

HE 5750

Solenoid valve controller



Operating instructions

(Translation of Original German version)

#371627

HESCH
AUTOMATION



Imprint

HESCH Industrie-Elektronik GmbH
Boschstraße 8
31535 NEUSTADT, GERMANY
Phone: +49 5032 9535-0
Internet: www.hesch-automation.com
Email: info@hesch.de

District Court Hanover
HRB 111184
VAT.-Id. No. DE813919106

General Management
Werner Brandis
Published by:
HESCH Industrie-Elektronik GmbH, Documentation Department

Copyrights



© Copyright 2022 HESCH Industrie-Elektronik GmbH. All rights reserved. The content including pictures and the design of these operating instructions are subject to copyright protection and other laws for the protection of intellectual property. The operating instructions may only be distributed as a complete document and only with reference to the source. The modification of the contents of this operating instructions is prohibited. In addition, this content may not be copied, distributed, modified or made available to third parties for commercial purposes.

Document history

Date / Version / Software version	Description / Author
2021-06-21 / 1.0 / 2.16	Operating instructions written based on HE 5750 with option central dust sensor (#371617, version from 2020-01-22, software version 2.15) Chapter HE 5750 switch unit added
2021-07-21 / 1.1 / 2.17	Chapter <i>Pre-pressure control</i> and <i>Change of units in 'SmartTool'</i> added as well as a few parameters

TABLE OF CONTENTS

1	LEGAL PROVISIONS	7
2	SAFETY INFORMATION	8
2.1	SYMBOLS AND BASIC SAFETY INSTRUCTIONS	8
2.2	SIGNAL WORDS	8
2.3	SAFETY IN THE INDIVIDUAL OPERATING PHASES	9
2.3.1	<i>Unpack device</i>	9
2.3.2	<i>Mounting</i>	9
2.3.3	<i>Power Connection</i>	9
2.3.4	<i>Commissioning</i>	10
2.3.5	<i>Troubleshooting</i>	10
2.3.6	<i>Decommissioning</i>	10
2.3.7	<i>Maintenance, repair and modification</i>	11
2.3.8	<i>Explosion Prevention</i>	11
3	TECHNICAL DATA	12
4	SKETCH OF FILTER SYSTEM	13
4.1	GLOSSARY	13
5	DEVICE DESCRIPTION	15
5.1	FRONT VIEW	15
5.2	GENERAL DESCRIPTION	15
5.3	COMMUNICATION STRUCTURE	16
5.4	SYSTEM SETUP	16
5.5	SYSTEM LAYOUT	17
5.6	COMPONENTS	18
5.6.1	<i>Master controller cabinet</i>	18
5.6.2	<i>Damper controller cabinet</i>	18
5.6.3	<i>Valve controller (Slave Box)</i>	18
5.6.4	<i>HE 1149 pressure transmitter, manifold pressure sensor</i>	19
5.6.5	<i>Possible differential pressure sensors</i>	19
6	INSTALLATION AND HOUSING	20
6.1	POWER SUPPLY	20
6.2	DEVICE DIMENSIONS	20
7	COMMISSIONING	21
7.1	INPUTS AND OUTPUTS (REAR VIEW HE 5750)	21
7.2	STANDARD ASSIGNMENT OF LOCAL OPERATING ELEMENTS	21
7.3	GALVANIC ISOLATION	22
7.4	SETTING THE COMMON BAUD RATE IN THE CAN NETWORK	23
7.5	SETTING THE DAMPER NUMBER (ADDRESS)	24
7.5.1	<i>HE 5750 (Master)</i>	24
7.5.2	<i>HE 5750 (Slave)</i>	24
7.5.3	<i>HE 5740 (Damper controller boxes)</i>	24
7.5.4	<i>Network topology</i>	24
7.6	LOCAL OPERATION ON THE SWITCH CABINET	25
7.7	LIMITATION OF LOCAL OPERATION	25
7.8	NETWORK TOPOLOGY SKETCH	26
7.8.1	<i>1 Slaves per chamber</i>	26
7.8.2	<i>2 Slaves per chamber</i>	27
7.9	CHANGE OF UNITS IN 'SMARTTOOL'	28
7.10	SYSTEM START	29

8	DISPLAY AND OPERATING ELEMENTS	30
8.1	NUMERIC KEYPAD AND INPUT BLOCK	30
8.2	FUNCTION KEYS F5-F16	31
8.2.1	Actual system status F5	31
8.2.2	Alarms F6	33
8.2.3	Info screen F7	33
8.2.4	Service screen F2	33
8.2.5	Standby mode F3 (when operated with switch unit only)	33
8.2.6	Screen up / screen down keys F8 and F16	34
8.2.7	Lamp test F9	34
8.2.8	Test functions F10	34
8.2.9	Acknowledging alarms F11	34
8.2.10	Graphic (Delta-p / dust development / filter cycle time) F12	35
8.2.11	Chamber status F13	35
8.2.12	Isolation valves F14	36
8.2.13	Chamber isolation F15	36
8.3	CONTEXT-SENSITIVE KEYS F1-F4	37
8.4	FILTER CYCLE TIMES	40
9	PARAMETER	41
9.1	ACCESSING PARAMETER MENU	41
9.2	PARAMETER GROUPS	41
9.3	PASSWORDS	41
9.4	PARAMETER TABLE (PARAMETER GROUPS 1-6)	42
9.4.1	Parameter description (parameter groups 1-6)	43
9.5	PARAMETER TABLE (PARAMETER GROUPS 7-12)	48
9.5.1	Parameter description (parameter groups 7-12)	49
9.6	PARAMETER TABLE (PARAMETER GROUPS 13-19)	52
9.6.1	Parameter description (parameter groups 13-19)	54
10	COMMANDS	59
10.1	COMMAND SOURCES	59
10.2	COMMAND DIAGRAM	60
10.3	LOCAL OPERATION / REMOTE CONTROL	61
11	ALARM AND ERROR MESSAGES	62
11.1	SYSTEM START	62
11.2	ALARM SCREENS	63
11.3	ALARMS OF CURRENT OPERATION	65
11.3.1	Sensor error	66
11.3.2	Pressure error	66
11.3.3	Damper error	67
11.3.4	Valve Controller Bus Error	67
11.3.5	Valve error	68
11.3.6	Valve controller manifold pressure-sensor error	68
11.3.7	Valve controller isolation valve-error	68
11.3.8	Valve Controller dust sensor-error	69
11.3.9	Valve controller tank pressure-error (sensor ok)	69
11.3.10	Valve controller valve error dust too high	69
11.3.11	Valve controller dust too high	69
11.3.12	Hopper level	69
11.3.13	Valve controller isolation valve locked	69
12	COMMUNICATION	70
12.1	MASTER-SLAVE CAN COMMUNICATION	70

12.2	DATA DIRECTION PLC -> HE 5750.....	71
12.3	DATA DIRECTION HE 5750 -> PLC.....	73
12.4	DIAGNOSIS HE 5750 AT PLC.....	75
13	SOLENOID VALVE CONTROLLER	78
13.1	DESCRIPTION.....	78
13.2	SUPPLY HE 5724.....	78
13.3	STATUS DIAGNOSIS HE 5724	79
13.4	TERMINALS AND JUMPERS.....	80
13.5	CAN WIRING AND BUS TERMINATION	81
14	PRE-PRESSURE CONTROL	82
15	OPTIONS	83
15.1	CENTRAL DUST MONITORING	83
15.1.1	<i>Reset dust valves</i>	<i>85</i>
15.2	HE 5750 SWITCH UNIT	86
15.2.1	<i>Safety Information.....</i>	<i>86</i>
15.2.2	<i>Device description of switch unit.....</i>	<i>87</i>
15.2.3	<i>Display and Operating Elements</i>	<i>91</i>
15.2.4	<i>Technical data of switch unit.....</i>	<i>92</i>
15.2.5	<i>Pin assignment</i>	<i>93</i>
16	MAINTENANCE AND SERVICE.....	94

1 Legal Provisions

Manufacturer

HESCH Industrie-Elektronik GmbH, Boschstraße 8, 31535 NEUSTADT, GERMANY.

Intended use

The device is exclusively intended for the use as measuring and testing device in technical systems.

The device can be operated within the approved ambient conditions (see chapter 3 *Technical Data* without impairment of its safety.

The manufacturer is not liable for improper use and any resulting personal injury or material damage; the risk is borne solely by the user. Failure to comply with the above criteria for intended use will result in expiry of the warranty and liability for the device.

Personnel qualification

Only trained electricians with sufficient know-how in electrical engineering shall perform works at the valve controller.

The device shall only be operated by trained personnel. Only trained and professional persons who are accustomed to the dangers thereto shall perform maintenance and repair.

Device Safety

The device has been constructed and tested in accordance with VDE 0411 / EN 61010-1 and has left the factory in perfect safety condition. The device was reviewed prior to delivery and has passed the mandatory tests specified by the test protocol. To maintain this condition and to ensure a safe operation, the user must pay attention to the guidelines and warnings, which are included in such safety guidelines and the operating manual.

Unpack device

Unpack device and accessories.

Enclosed standard accessories: Operating instruction and fixing elements, if necessary. The delivery must be checked for correctness and completeness. The device shall be inspected with regard to damage due to non-intended handling by transport and storage.



Warning!

If the device is damaged in a way that indicates that safe operation is not possible, the device must not be put into operation.

2 Safety Information

2.1 Symbols and Basic Safety Instructions

This chapter contains important safety regulations and notes. To protect against personal injury and material damage, it is necessary to read this chapter carefully before working with the device.

Symbols used

The following symbols are used in this manual. All safety instructions have a uniform structure.



Personal Injury Warning!
The severity of the danger is indicated by the respective signal word.



Explosive region warning sign!



High Voltage Warning!



Warning of material damage caused by electrostatic charge!



Property Damage Warning!



Note!
Identifies possible malfunctions and indicates optimum operating conditions.

2.2 Signal words

DANGER!

Indicates an imminently hazardous *high* risk situation, which, if not avoided, will result in death or serious injury.

WARNING!

Indicates a potentially hazardous medium risk situation, which, if not avoided, could result in death or serious injury.

CAUTION!

Indicates a hazardous low risk situation, which, if not avoided, could result in minor or moderate injury.

2.3 Safety in the individual operating phases

When installing the device and during operation, the following safety instructions must be observed.



Attention!

During installation, commissioning, maintenance and troubleshooting, observe the accident prevention regulations applicable to your system, e.g. DGUV Regulation 3 "Electrical installations and equipment".

2.3.1 Unpack device



Warning of personal injury and property damage!

The device shall be inspected with regard to damage due to non-intended handling by transport and storage. If the device is damaged in a way that indicates that safe operation is not possible, the device must not be put into operation.

2.3.2 Mounting



Warning of personal injury and property damage!

The device is to be installed in places that comply with the protection class. The ambient temperature at the installation site must not exceed the permissible temperature for rated use specified in the technical data. The device must only be installed outside of potentially explosive atmospheres!

2.3.3 Power Connection



Danger of Electrocutation!

Before working on the device, switch off all power supplies used. The electrical cables must be laid according to the respective national regulations (in Germany VDE 0100). The measuring cables must be laid separately from the power lines. Connect the protective earth connector (in the respective device carrier) to the protective earth conductor. It is recommended to use twisted and shielded measuring leads to avoid the influence of interference fields. The electrical connection takes place according to the wiring diagrams / wiring images of the respective device.

2.3.4 Commissioning

Before switching on the device, it must be ensured that the following points are fulfilled:

- ✓ The power supply must correspond to the voltage indicated on the nameplate.
- ✓ All covers required for contact safety must be fitted.
- ✓ If the device is linked to other devices and/or equipment, consider the impacts and take appropriate precautions before switching it off.
- ✓ The protective conductor connection in the respective device carrier must be connected to the protective conductor (for devices with protection class I).



Warning of personal injury and property damage!

Any interruption of the protective earth in the equipment carrier can result in the device becoming a hazard. Intentional interruptions are not permitted. If there is a suspicion that it is no longer possible to operate the device safely, it must be shut off and secured against being unintentionally switched on.



Attention!

The device must never be put into operation even if damage is recognisable.

2.3.5 Troubleshooting

At the beginning of troubleshooting, all possible sources of faults on additional devices or supply lines (measuring lines, wiring and downstream devices) should be taken into consideration. If the fault is not found after checking these points, we recommend sending the device to the supplier.



Danger of Electrocution!

Do not open the device when it is connected to the voltage! When opening the devices or removing covers and parts, live parts may be exposed. Connection points can also be live!

2.3.6 Decommissioning



Attention!

If the device is to be taken out of operation, the auxiliary power must be switched off at all poles. The device must be protected against unintended operation. If the device is linked to other devices and/or equipment, consider the impacts and take appropriate precautions before switching it off.

2.3.7 Maintenance, repair and modification

The devices do not require special maintenance.

Modifications, maintenance and repair must be performed by trained professional personnel only.

If the failure of a fuse is detected, the cause must be inspected and eliminated. The replacement fuse must have the same data as the original type.

The use of patched fuses or short circuiting the fuse holder are not allowed.



Warning!

When opening the devices or removing covers and parts, live parts may be exposed. Connection points can also be live. The device must be disconnected from all voltage sources prior to these works.



Property damage caused by electrostatic charge!

When opening the devices, components may be exposed that are sensitive against electrostatic discharge (ESD).

The following works must only be performed at work places that are protected against ESD!

2.3.8 Explosion Prevention



Explosion Prevention!

Devices without explosion protection are not allowed to be operated in potentially explosive spaces. Furthermore, the output and input circuits of the device / device carrier must not lead into potentially explosive spaces. Except for the devices with EX declaration of conformity! For these EX devices, the information in the associated declaration of conformity and the respective national regulations for setting up electrical systems in potentially explosive areas must also be taken into account.

3 Technical Data

Supply voltage	24 VDC (18...30 VDC)
Display	Graphic LC display, 240 × 64 pixel, 133 × 39 mm Colour: green, backlight: LED
Keyboard	Membrane keyboard, 16 function keys, description customer specific. Numeric key pad, cursor / control key pad
Real-time clock	Date, time (power failure buffer: approx. 1 year)
μ processor	Siemens C167CR
Memory	256 kByte static RAM 512 kByte FLASH Data 512 kByte FLASH program 8 kByte parallel EEPROM
Inputs 'on board'	4 × analogue: 4...20 mA, block galvanically isolated 8 × digital: 24 VDC galvanically isolated
Outputs	8 × digital: 24 VDC galvanically isolated. Short-circuit proof
CAN-BUS	According to ISO 11898, max. 1 Mbit/s Specification: 2.0A Supply: galvanically isolated
Profibus-DP	According to EN 50 170, max. 12 Mbit/s automatic baud rate recognition RS 485
Serial interface	RS 232 and RS422 or RS 485 selectable via software Baud rate: max. 38400 bit/s
Housing	Control panel installation Protection class: front IP54, back IP20
Dimensions	295 × 200 × 40 mm (W × H × D) Required cut-out: 265 × 170 mm
Jumper	XJ1: CAN-BUS termination (bus termination). Must not be done, if termination has already been done externally at the connection.  XJ2: dust sensor jumper, analogue or switch contact XJ3: dust sensor jumper, analogue or switch contact
Shock resistance	DIN 40046 IEC68-2-69
EMC	DIN EN 50081 part 1 DIN EN 50082 part 2
Electrical connection	Via plug / screw-on terminals (max. diameter 2.5 mm ²)
Storage at	- 20 °C...+ 70 °C
Operation at	0 °C...+ 50 °C
Relative humidity	75% relative humidity permanently, non-condensing

Subject to technical changes without notice!

4 Sketch of filter system

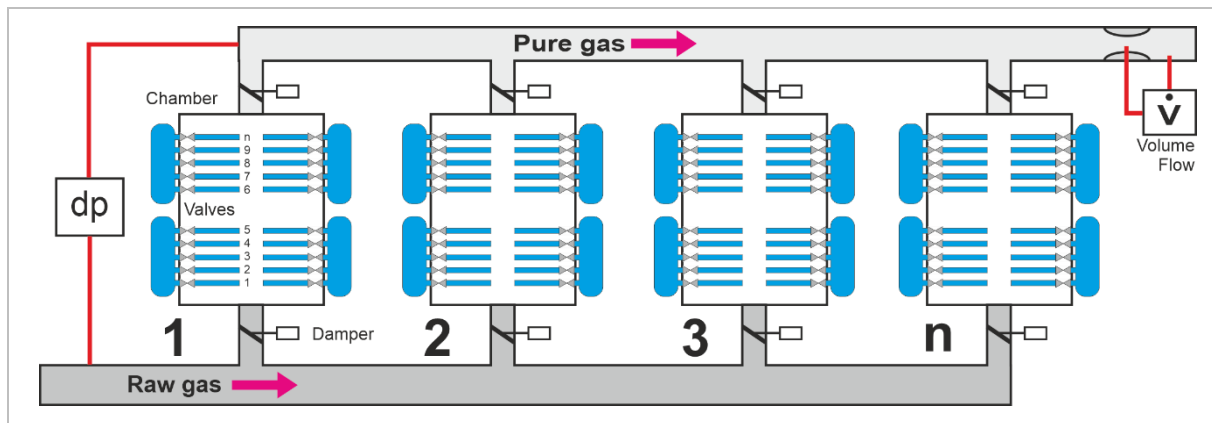

Figure 1. Filter system

4.1 Glossary

Valve sequence	A valve offset of 2 causes: valve 1, valve 3, valve 5 ... are triggered
Chamber sequence	A chamber offset of 1 causes: chamber 1, chamber 2, chamber 3 are cleaned. A chamber offset has higher priority than a valve offset. A chamber offset of 0 causes: all valves acc. to valve sequence in chamber 1 are pulsed. Then chamber 2 and so on...
Operating modes:	
permanent	Permanent processing of the parametrised valve sequence. Control via start / stop signals.
dp threshold	Control of the cleaning process via the dp signal. Cleaning starts when the parametrised upper threshold is exceeded; stops when dropping below lower threshold.
dp controller	dp signal and flow rate signal influence the cleaning process. Depending on the filter characteristic to be set via interpolation points, the pause time is controlled or regulated.
Online cleaning	The dampers for pure gas and raw gas stay open during cleaning.
Offline cleaning	During cleaning of a chamber, the selected dampers are closed. Within the chamber the valve sequence is applied. After chamber cleaning, the chamber sequence is considered.
Semi Compartment Offline Cleaning (SCOC)	'Semi Compartment Offline Cleaning'. Requires two pure gas dampers per chamber. Thus, one half of the chamber can be cleaned offline, while the other half remains in the filter process.
Post-cleaning	Post cleaning may be required if the complete filter has been taken out of the process. The post-cleaning extends over the complete filter and performs the parameterised number of cycles / valves, etc.. The post cleaning uses 'cycletime 2'.
Background cleaning	The background cleaning becomes active if no 'regular' cleaning is performed for a parameterisable time. This is often the case in small flow rates or low dust inputs. The differential pressure is reviewed regarding a minimum value at the same time. If the value falls below this, it is assumed that there is no fan operation and cleaning will not continue.

Partial cycle	Cleaning runs as long as the required start conditions are present. If the start condition is missing, the cleaning will be interrupted. The cleaning then will be continued at interruption point.
Complete cycle	If the required start condition is set, a cleaning cycle via all active valves is performed.
Forced cleaning	Independently of other necessary conditions (e.g. dp-thresholds) the setting of this condition starts the cleaning process. Cleaning runs as long as the condition is set or at cleaning cycle until all active valves are cleaned. In connection with the operating mode partial cycle the valves can be individually processed.
Drain valves	The control supports the drain valves at the local manifold. Parameter 4.14 to 4.16

5 Device Description

5.1 Front view

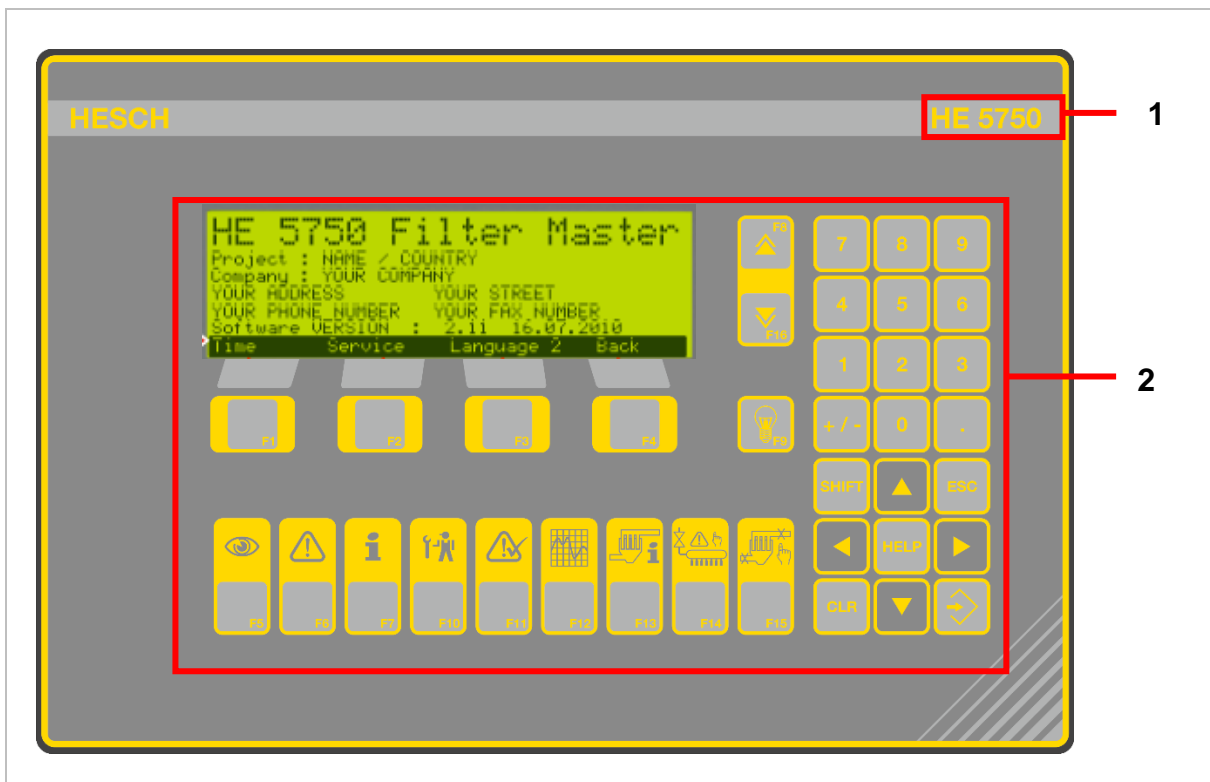

Figure 2. HE 5750 front

- 1 Device designation
- 2 Display and operating elements

5.2 General Description

The system controller HE 5750 is the central unit in a CAN based network of the cleaning controller for industrial hose filters. The central control communicates with the decentralised valve control units HE 5724 and the damper control units HE 5740 via the industrial CAN bus. The central controller takes over the coordination and monitoring of all connected components as well as the communication with the process control.

The Slave controllers HE 5724 monitor the valve control and monitoring process. The damper controller units are the interface to the damper actuators.

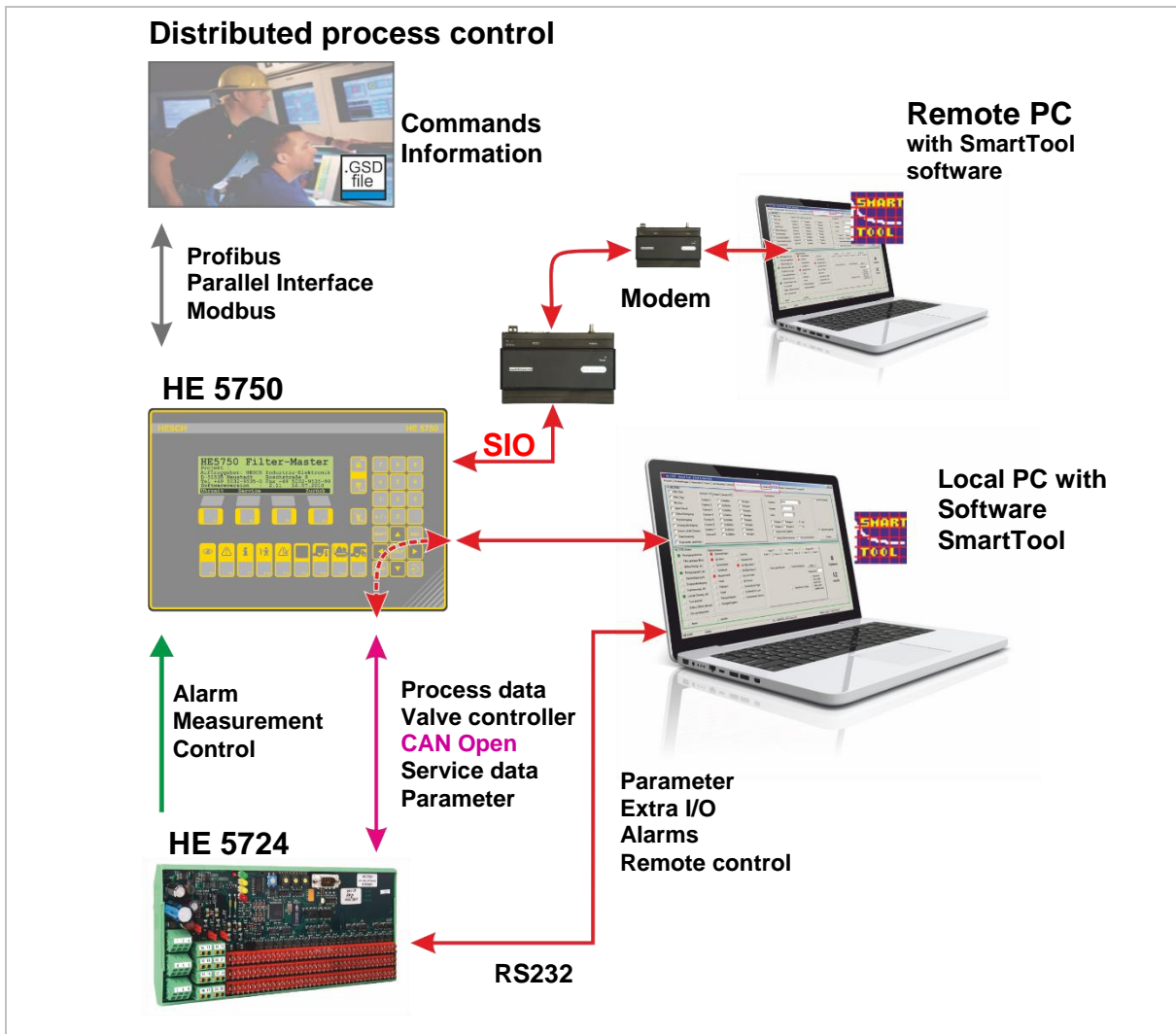

Figure 3. Communication structure

5.3 Communication structure

The central controller HE 5750 is the master in the CAN bus system of the filter controller system. A PROFIBUS-DP or a ModBUS interface are available for the process control. Alternatively, a parallel interface for the binary signal exchange is available. However, the complete signal list can only be accessed via the serial interfaces.

5.4 System setup

After installing the units amongst each other correctly, the parameters can be setup. A complete parameter list with descriptions can be found in chapter 9.4 *Parameter table (parameter groups 1-6)* to 9.6 *Parameter table (parameter groups 13-19)*.

The operation parameters can either be set via the keys of the central controller or via the software 'SmartTool'. The configuration of the 'Extra I/O' is possible via 'SmartTool' only. With the free version of 'SmartTool', parameters can be downloaded from the controller and saved. Original project data can be restored. See 'Short Manual' on the documentation CD.

With the option **remote maintenance** in 'SmartTool', a modem connection to the controller can be done to perform remote maintenance and diagnosis of systems.

5.5 System layout

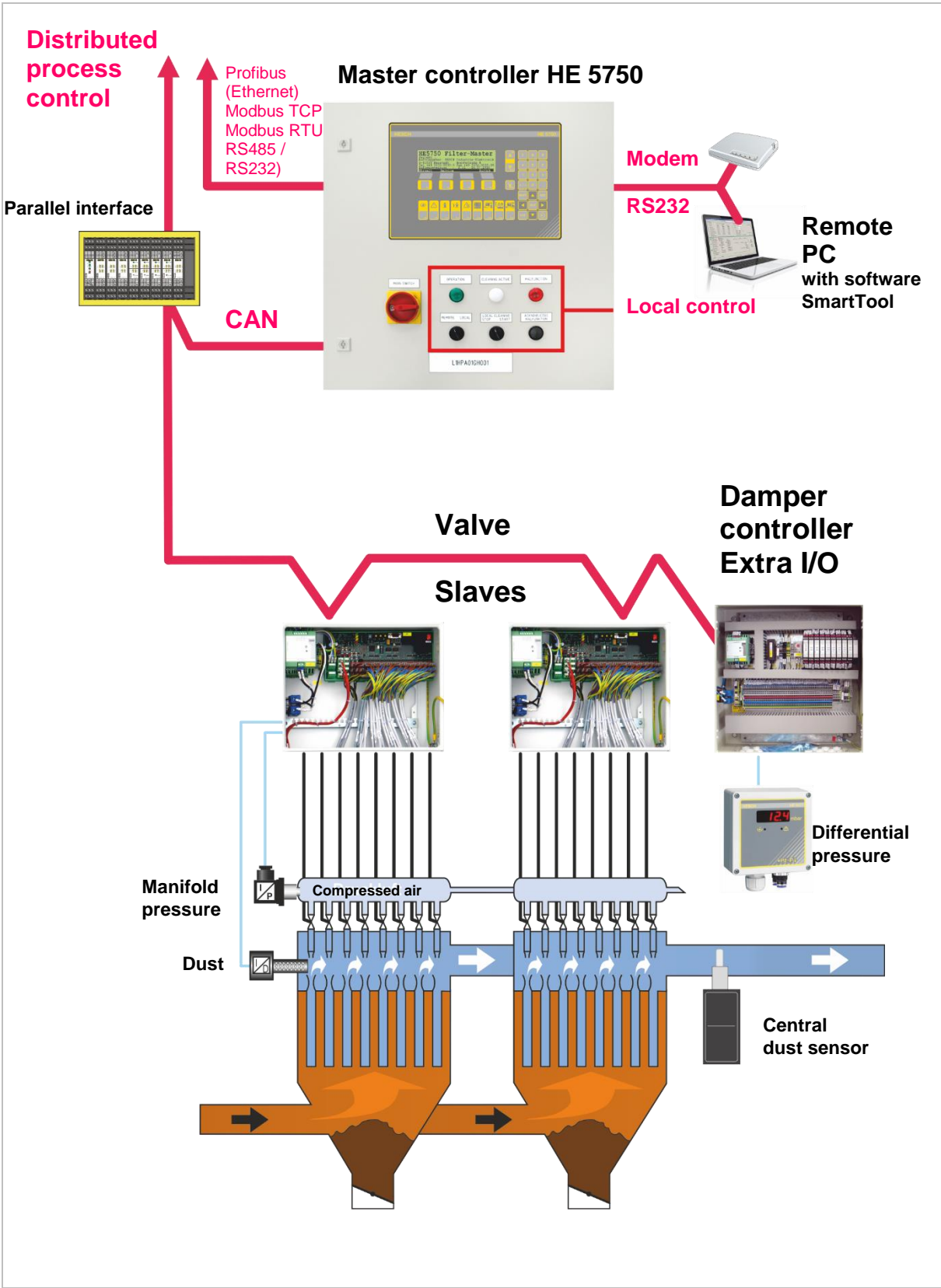
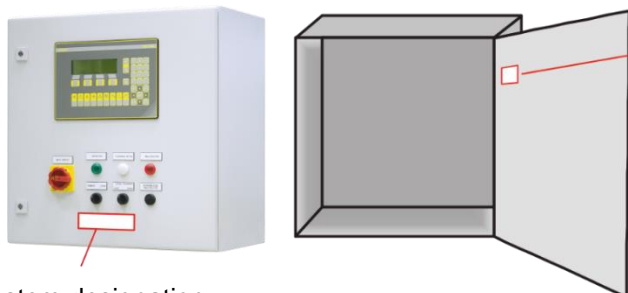

Figure 4. System layout

5.6 Components

5.6.1 Master controller cabinet

600 mm × 600 mm × 350 mm (W × H × D)
Weight: 28.5 kg



System designation

HESCH AUTOMATION PARTNER			
+49 (0) 5032 / 9353-0 D-31535 Neustadt www.hesch.de			
Typ type	Master Control Unit		
Betr.-spann. operating volt.	100...240V AC	Baujahr manufactured	2014
Frequenz frequency	50 or 60 Hz	Sicherung to be fused with	max. 32A
Steuerspann. control voltage	24V DC	Umgeb.-temp. ambient temp.	-10...55°C
Schutzart protection class	IP 54	Artikelnummer article No.	68050410
		Seriennummer serial No.	68050401
DIN EN 60439-1	CE	Node Address	43

5.6.2 Damper controller cabinet

500 mm × 500 mm × 210 mm (W × H × D)
Weight: 16.8 kg
or:
600 mm × 600 mm × 210 mm (W × H × D)
Weight: 22.8 kg

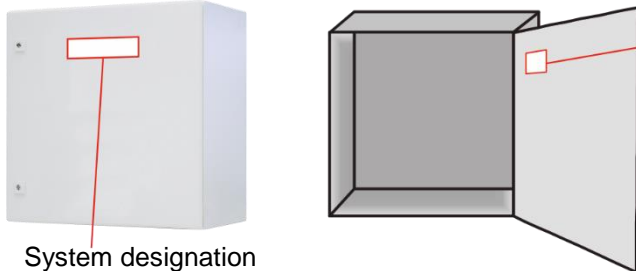

System designation

HESCH AUTOMATION PARTNER			
+49 (0) 5032 / 9353-0 D-31535 Neustadt www.hesch.de			
Typ type	Damper Control Unit		
Betr.-spann. operating volt.	100...240V AC	Baujahr manufactured	2014
Frequenz frequency	50 or 60 Hz	Sicherung to be fused with	max. 6A
Steuerspann. control voltage	24V DC	Umgeb.-temp. ambient temp.	-10...55°C
Schutzart protection class	IP 55	Artikelnummer article No.	68050430
		Seriennummer serial No.	68050402
DIN EN 60439-1	CE	Node Address	33

5.6.3 Valve controller (Slave Box)

380 mm × 300 mm × 155 mm (W × H × D)
Weight: 7.5 kg

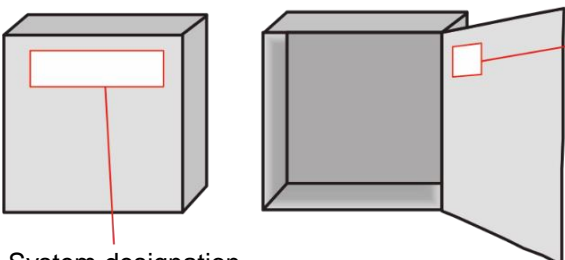

System designation

HESCH AUTOMATION PARTNER			
+49 (0) 5032 / 9353-0 D-31535 Neustadt www.hesch.de			
Typ type	Valve Control Unit		
Betr.-spann. operating volt.	100...240V AC	Baujahr manufactured	2014
Frequenz frequency	50 or 60 Hz	Sicherung to be fused with	max. 6A
Steuerspann. control voltage	24V DC	Umgeb.-temp. ambient temp.	-10...55°C
Schutzart protection class	IP 55	Artikelnummer article No.	68050420
		Seriennummer serial No.	68050404
DIN EN 60439-1	CE	Node Address	01

5.6.4 HE 1149 pressure transmitter, manifold pressure sensor

78 mm x 48 mm (W x H)

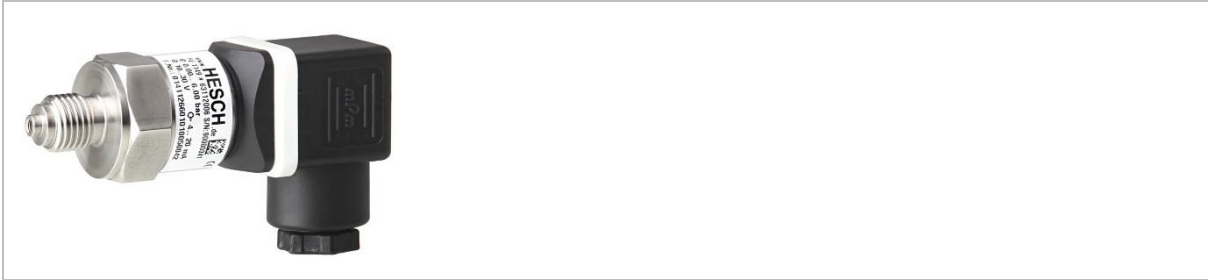

5.6.5 Possible differential pressure sensors

HE 5421

120 mm x 122 mm x 55 mm (W x H x D)

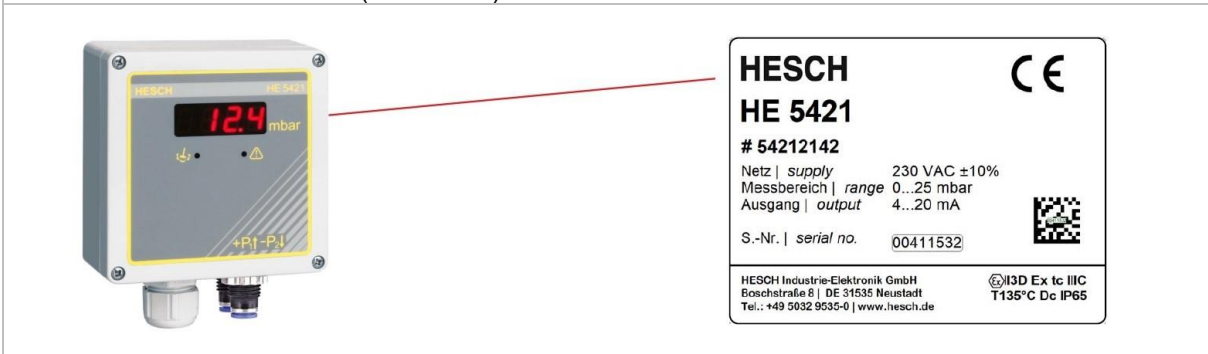

HE 5422

151 mm x 160 mm x 61 mm (W x H x D)

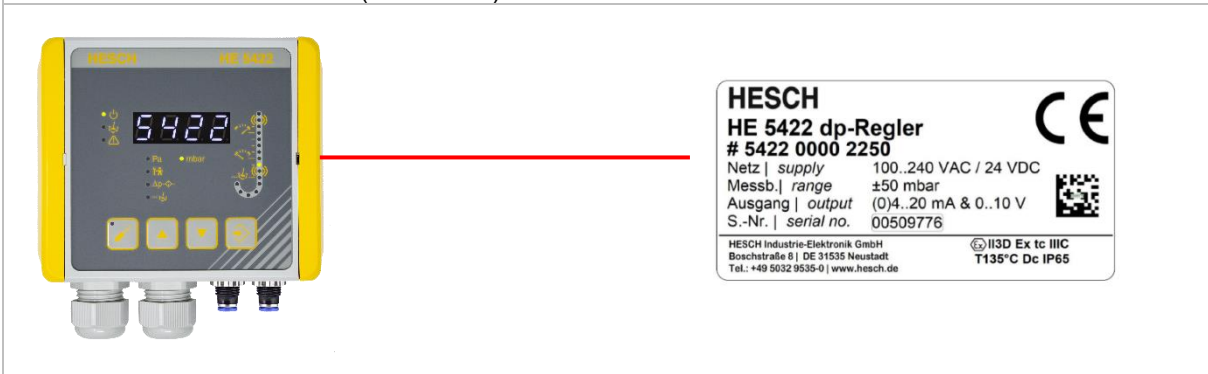

HE 5422 MR (with measuring hose cleaning)

200 mm x 150 mm x 100 mm (W x H x D)



6 Installation and housing

The device must be assembled in a way that it is protected against humidity and contamination. The permissible ambient temperature (50°C) must not be exceeded. The electrical connections must be performed according to the relevant VDE or local regulations. The connection of the device must always take place in voltage-free condition. Contactors in the control cabinet must be suppressed with RC networks. The device has got a network filter. In case of transient interference voltages, an additional external line filter may be required. The line filter is not included in the standard delivery, but can be ordered from HESCH Industrie-Elektronik GmbH.

6.1 Power supply

The controller requires 24 V DC. The power consumption is approx. 0.5 A.



Attention!

Before switching the device on, check for correct voltage level. In case of a faulty connection, the device may be severely damaged.

6.2 Device dimensions

Device dimensions

295 × 200 × 40 mm (W × H × D)

Control panel cut-out

265 × 170 mm

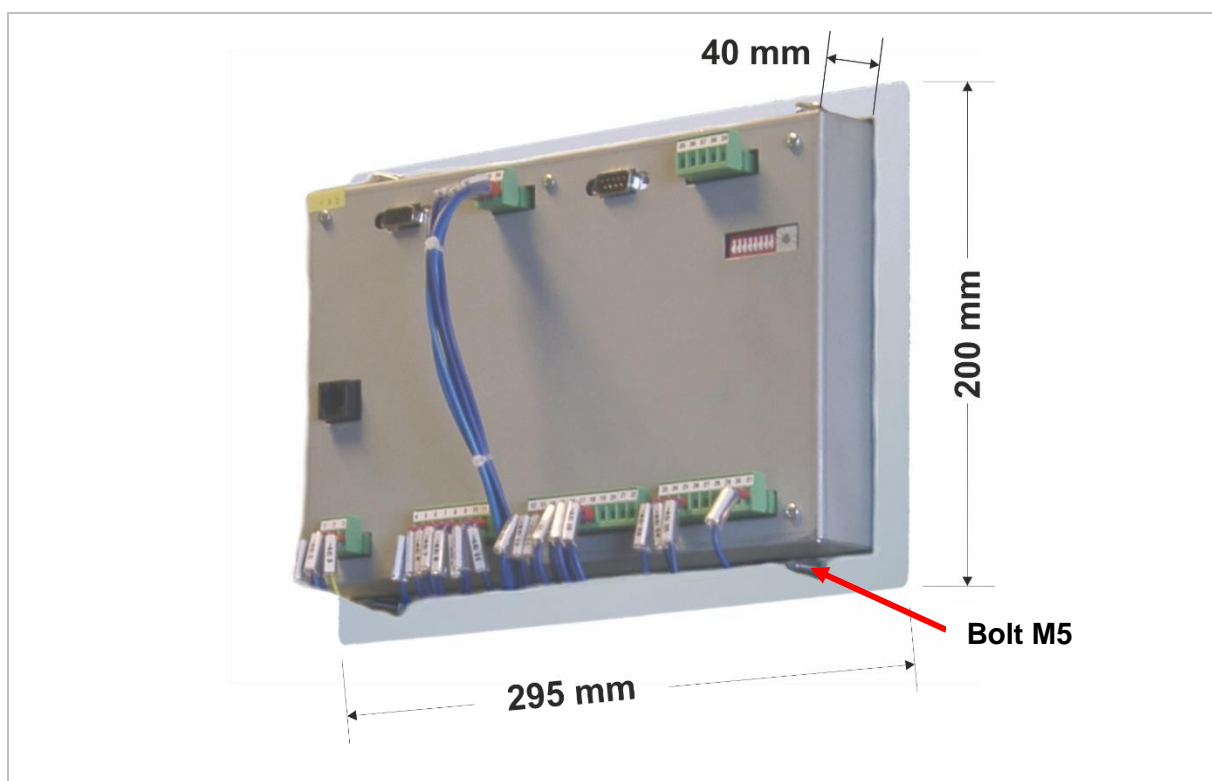

Figure 5. HE 5750 rear view

7 Commissioning

7.1 Inputs and outputs (rear view HE 5750)

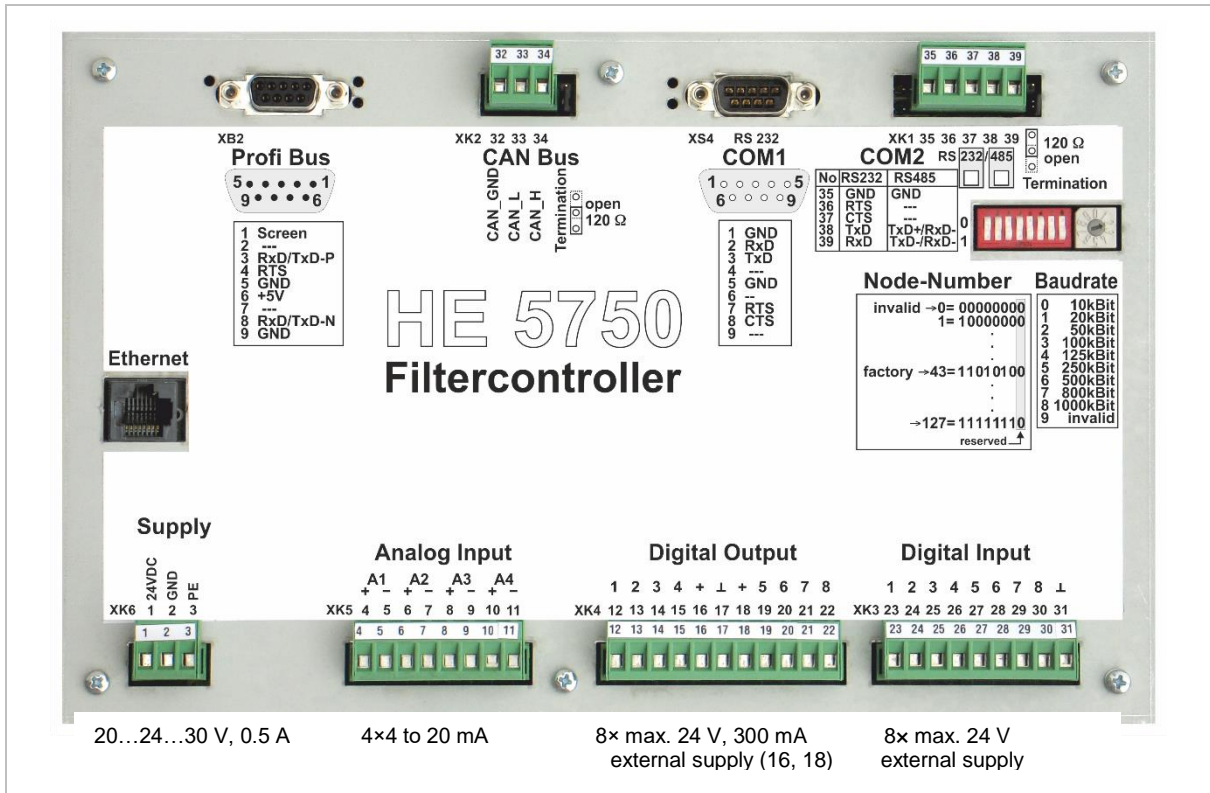

Figure 6. Inputs and outputs

7.2 Standard assignment of local operating elements

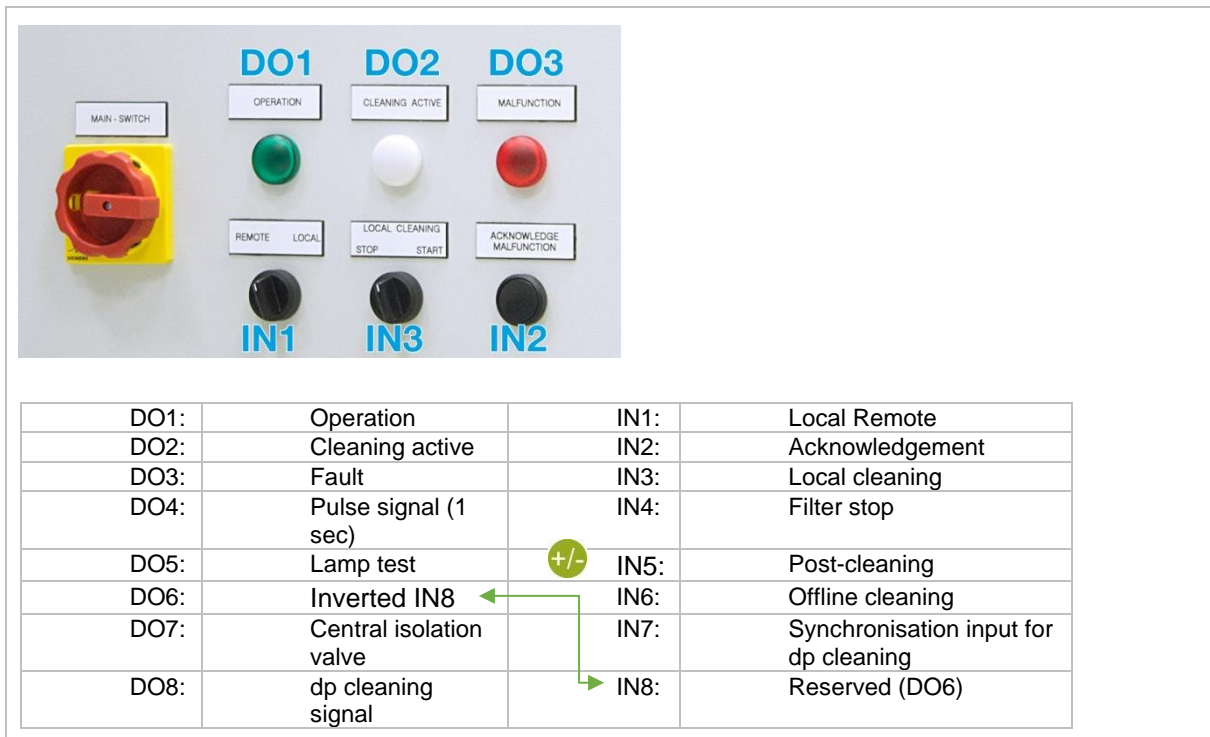

Figure 7. Standard assignment of local operating elements

7.3 Galvanic isolation

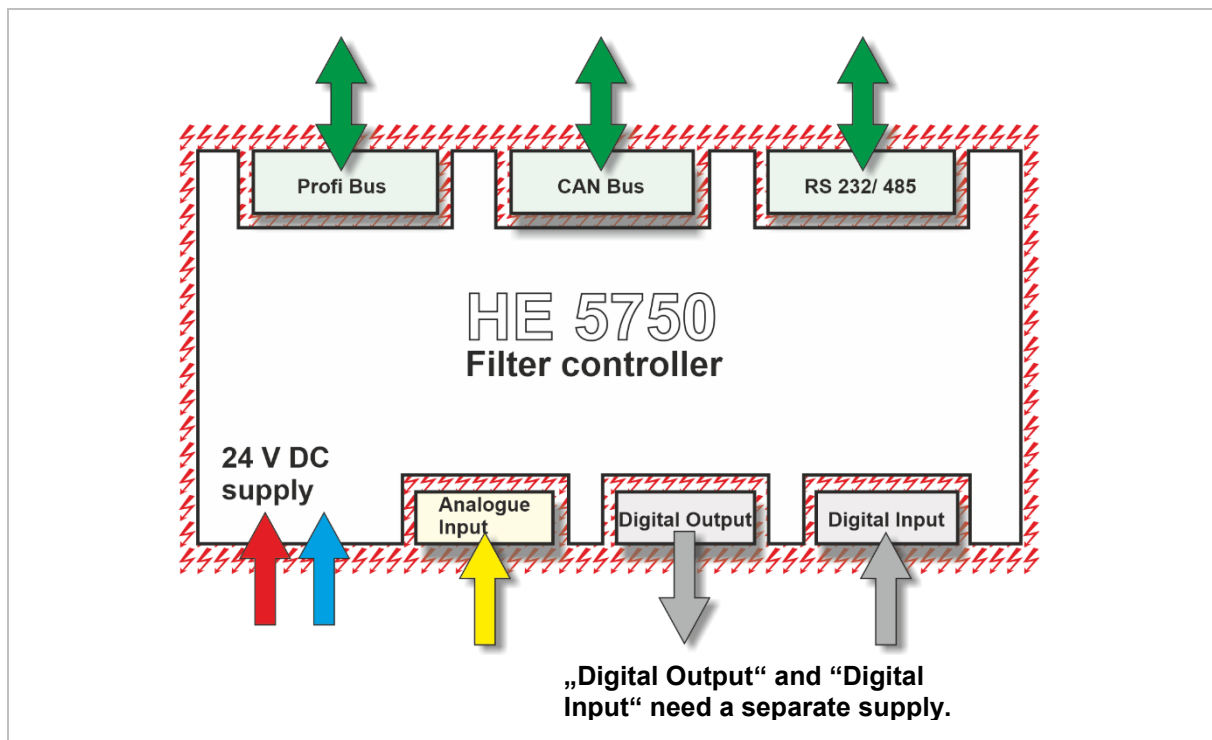

Figure 8. Galvanic isolation

7.4 Setting the common baud rate in the CAN network

All participating components in the CAN network must have the same baud rate. Limits for the max. baud rate are set by the net extension.



Note!

Basically the rule is: only as quick as necessary, not as quick as possible. The default setting is 50 kBd,

Master setting																							
	<table border="1"> <thead> <tr> <th>Node-Number</th> <th>Baudrate</th> </tr> </thead> <tbody> <tr> <td>invalid → 0 = 00000000</td> <td>0 10kBit</td> </tr> <tr> <td>1 = 10000000</td> <td>1 20kBit</td> </tr> <tr> <td>⋮</td> <td>2 50kBit</td> </tr> <tr> <td>factory → 43 = 11010100</td> <td>3 100kBit</td> </tr> <tr> <td>⋮</td> <td>4 125kBit</td> </tr> <tr> <td>⋮</td> <td>5 250kBit</td> </tr> <tr> <td>⋮</td> <td>6 500kBit</td> </tr> <tr> <td>→ 127 = 11111110</td> <td>7 800kBit</td> </tr> <tr> <td>reserved ↗</td> <td>8 1000kBit</td> </tr> <tr> <td></td> <td>9 invalid</td> </tr> </tbody> </table>	Node-Number	Baudrate	invalid → 0 = 00000000	0 10kBit	1 = 10000000	1 20kBit	⋮	2 50kBit	factory → 43 = 11010100	3 100kBit	⋮	4 125kBit	⋮	5 250kBit	⋮	6 500kBit	→ 127 = 11111110	7 800kBit	reserved ↗	8 1000kBit		9 invalid
Node-Number	Baudrate																						
invalid → 0 = 00000000	0 10kBit																						
1 = 10000000	1 20kBit																						
⋮	2 50kBit																						
factory → 43 = 11010100	3 100kBit																						
⋮	4 125kBit																						
⋮	5 250kBit																						
⋮	6 500kBit																						
→ 127 = 11111110	7 800kBit																						
reserved ↗	8 1000kBit																						
	9 invalid																						

Figure 9. Master setting

Slave setting:																																																
	<table border="1"> <thead> <tr> <th rowspan="2">Baudrate</th> <th colspan="3">Node-Number</th> </tr> <tr> <th>ten's</th> <th>unit</th> <th>Value</th> </tr> </thead> <tbody> <tr> <td>0 10kBit</td> <td>0</td> <td>0</td> <td>invalid</td> </tr> <tr> <td>1 20kBit</td> <td>0</td> <td>1</td> <td>1</td> </tr> <tr> <td>2 50kBit</td> <td>0</td> <td>2</td> <td>2</td> </tr> <tr> <td>3 100kBit</td> <td>⋮</td> <td>⋮</td> <td>⋮</td> </tr> <tr> <td>4 125kBit</td> <td>⋮</td> <td>⋮</td> <td>⋮</td> </tr> <tr> <td>5 250kBit</td> <td>⋮</td> <td>⋮</td> <td>⋮</td> </tr> <tr> <td>6 500kBit</td> <td>⋮</td> <td>⋮</td> <td>⋮</td> </tr> <tr> <td>7 800kBit</td> <td>⋮</td> <td>⋮</td> <td>⋮</td> </tr> <tr> <td>8 1000kBit</td> <td>⋮</td> <td>⋮</td> <td>⋮</td> </tr> <tr> <td>9 invalid</td> <td>9</td> <td>9</td> <td>99</td> </tr> </tbody> </table>	Baudrate	Node-Number			ten's	unit	Value	0 10kBit	0	0	invalid	1 20kBit	0	1	1	2 50kBit	0	2	2	3 100kBit	⋮	⋮	⋮	4 125kBit	⋮	⋮	⋮	5 250kBit	⋮	⋮	⋮	6 500kBit	⋮	⋮	⋮	7 800kBit	⋮	⋮	⋮	8 1000kBit	⋮	⋮	⋮	9 invalid	9	9	99
Baudrate	Node-Number																																															
	ten's	unit	Value																																													
0 10kBit	0	0	invalid																																													
1 20kBit	0	1	1																																													
2 50kBit	0	2	2																																													
3 100kBit	⋮	⋮	⋮																																													
4 125kBit	⋮	⋮	⋮																																													
5 250kBit	⋮	⋮	⋮																																													
6 500kBit	⋮	⋮	⋮																																													
7 800kBit	⋮	⋮	⋮																																													
8 1000kBit	⋮	⋮	⋮																																													
9 invalid	9	9	99																																													

Figure 10. Slave setting:

Network extension:	Baud rate [kBaud]	Network extension [m]
	500	100
	250	200
	100	600
	50	1200

Figure 11. Network extension:

7.5 Setting the damper number (address)

7.5.1 HE 5750 (Master)

The address is preset to 43. The LSB is on the left.

7.5.2 HE 5750 (Slave)

The permissible scope of address is between 1 and 32. The address is set with the two rotary coding switches S2 and S3.

In systems with one Slave per filter chamber the address runs from 1 to 24. In systems with 2 slaves per chamber, the address of the first chamber Slave is set to 1, the one of the second Slave to 17. In chamber 2 of the first slave to 2, and the second slave to 18 etc.

7.5.3 HE 5740 (Damper controller boxes)

Control units for 8 or 16 dampers are available. Units for raw gas dampers and pure gas dampers differ only in the device addresses.

Raw gas damper units start with the address 33. Further valid addresses are 34 and 35. Pure gas damper units start with the address 36. Further valid addresses are 37 and 38.

For setting, the communication card HE 5910 must be pulled out of the basic frame. There are 2 DIP switches on the PCB. The node address is set with the 8-bit switch. The 4-bit switch influences the baud rate. The LSB is on the right side.

Baud rate		Node n°	
0000	10 kBit	0000 0000	invalid
0001	20 kBit	0000 0001	1
0010	50 kBit	0000 0010	2
0011	100 kBit	0000 0011	3
0100	125 kBit
0101	250 kBit	0010 0000	32
0110	500 kBit
0111	800 kBit	0111 1110	126
1000	1000 kBit	0111 1111	127

Figure 12. Setting of damper controller boxes

7.5.4 Network topology

A purely serial structure is suggested. Each end of a network must be completed with 120Ω each. A terminating resistor to be activated accordingly is located on each CAN unit. Stub lines are to be avoided. Keep unavoidable stubs as short as possible and do not terminate them. By keeping a purely serial topology, the network extension can possibly be increased.

The used cable should be permissible for CAN bus operation. Note the diameter for more extension (\geq AWG18, 0.75mm²)!

7.6 Local operation on the switch cabinet

The control of the filter system can be started or stopped locally. The condition of the local controller is reported to the process control.

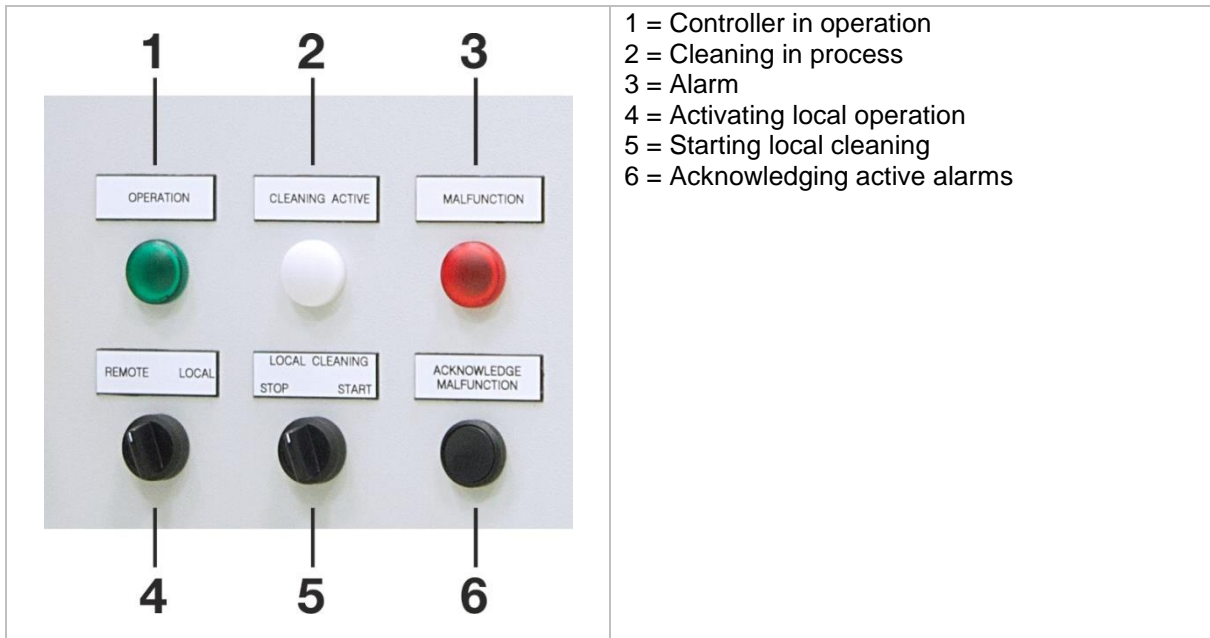

Figure 13. Operation on the switch cabinet

7.7 Limitation of local operation

The operation of the local control elements may be locked by a parameter.

Selection:

>F5, >F1: parameters >interfaces >local interface Yes / No.

Even if the local operation is locked, the indicator lights function.

The operation of the keys at the controller can be limited to 'display only' by the control level (remote operation, remote control = On). This limitation can only be reversed via the operator level or via 'SmartTool'. After expiration of the 'Remote timeout', the keyboard operation is unlocked again too, in case of an interruption of the connection to the process control.

7.8 Network topology sketch

7.8.1 1 Slaves per chamber

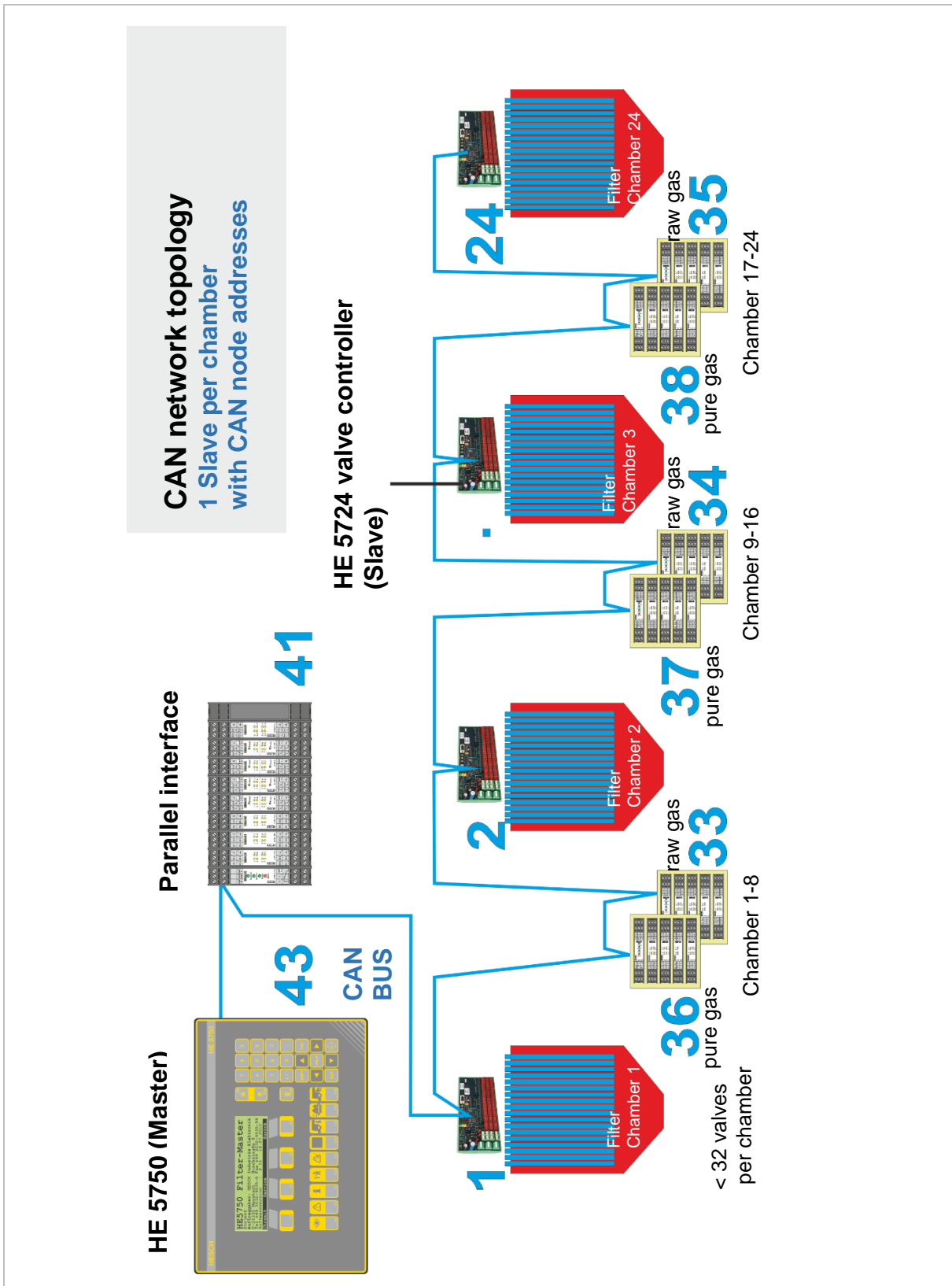

Figure 14. Network topology with 1 slaves per chamber

7.8.2 2 Slaves per chamber

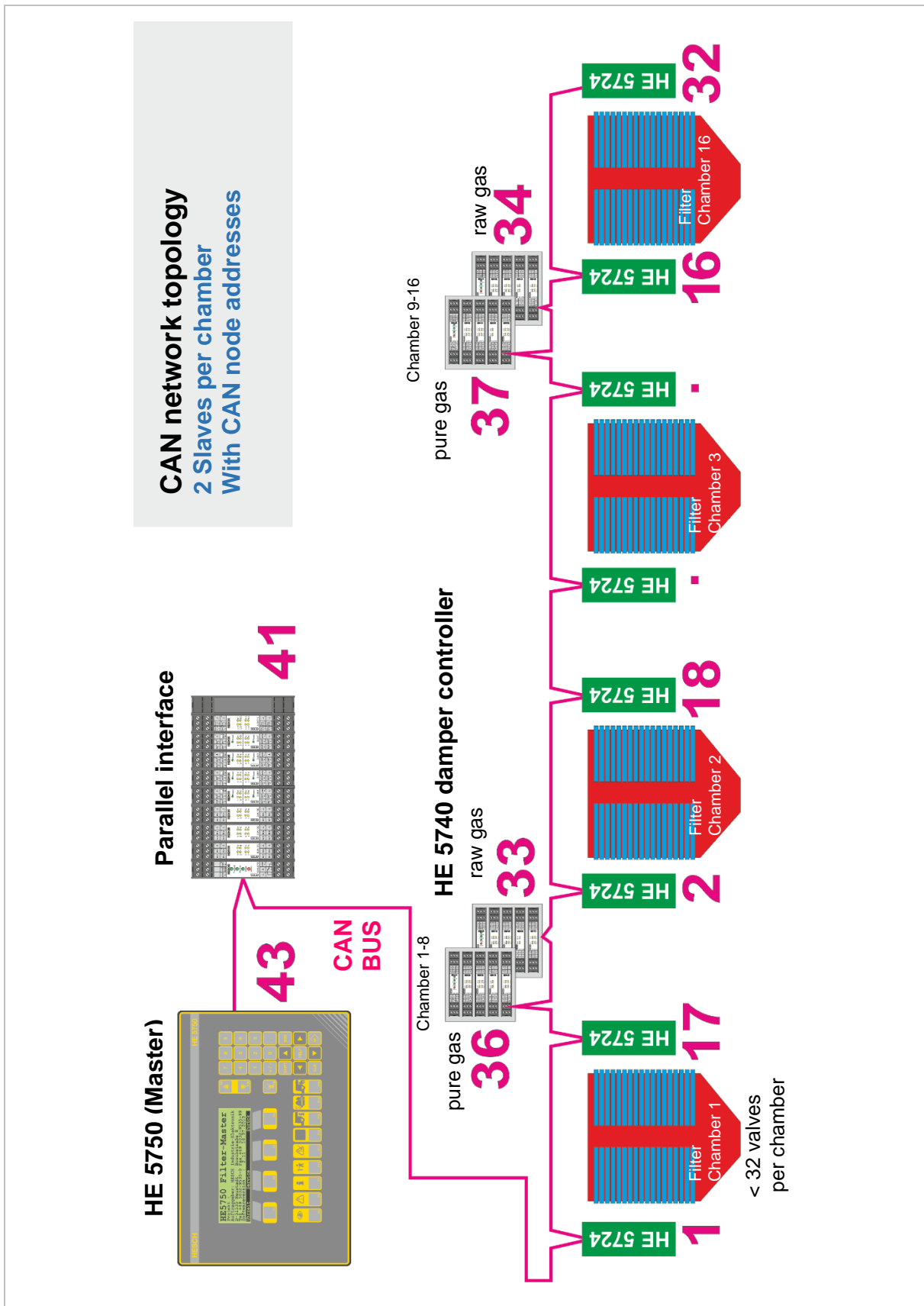

Figure 15. Network topology with 2 slaves per chamber

7.9 Change of units in 'SmartTool'

'SmartTool' offers the possibility of changing units as required by adapting the respective unit texts.

For example pressure units:

- System pressure, e.g. bar or psi ¹ (see *Figure 16*, line 295).
- Differential pressure, e.g. bar or iwg ² (see *Figure 16*, line 302).



Note!

If the unit of system pressure and differential pressure are changed, the measuring range of the pressure sensor must be adapted too, or a sensor with suitable measuring range must be used.

Also the alarm thresholds must have the correct pressure unit, except for indication of alarm threshold in percent %.

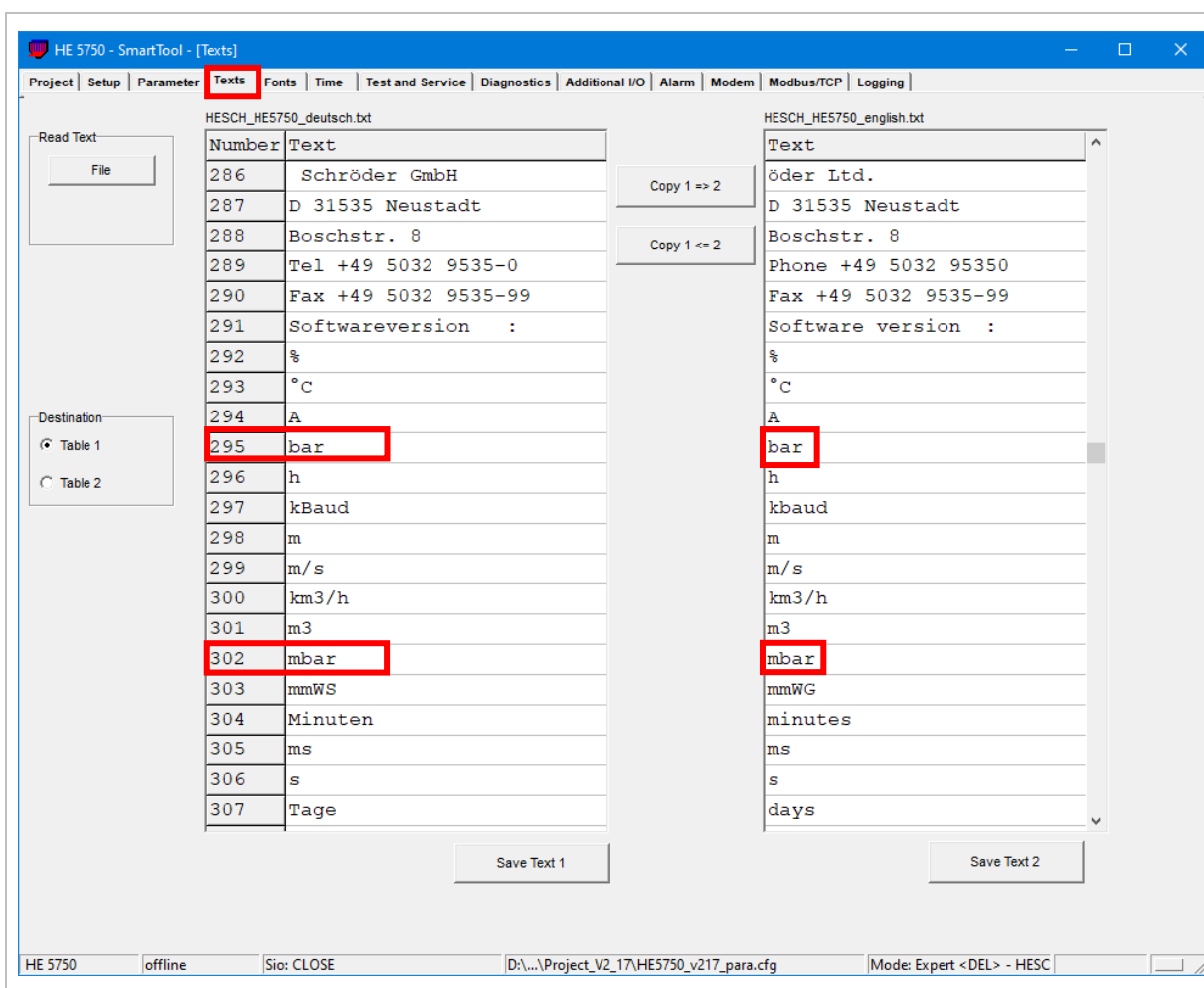

Figure 16. Screen in 'SmartTool' for changing the units

¹ Pound per square inch

² Inches of water gauge

7.10 System start

For a successful system start, the following conditions must be fulfilled:

- ✓ wiring all components according to wiring diagrams
- ✓ power supply of all components switched on
- ✓ system parameters completely entered
- ✓ compressed air for valves available

There are three different start options:

1. local control at Master control cabinet
2. start with SmartTool
3. start from process control

The active cleaning process is indicated on the display of the controller and by indicator lights at the control cabinet. A start with the controller is not possible.

Once the controller is switched on, it starts monitoring

- the CAN network,
- the conformity of parameter set and system
- the check of necessary values (pressures etc.)

Alarm messages (alarm triangle in system status screen) can be accessed by pressing the F6 key. Chapter 11 *Alarm and error* messages gives information about troubleshooting.

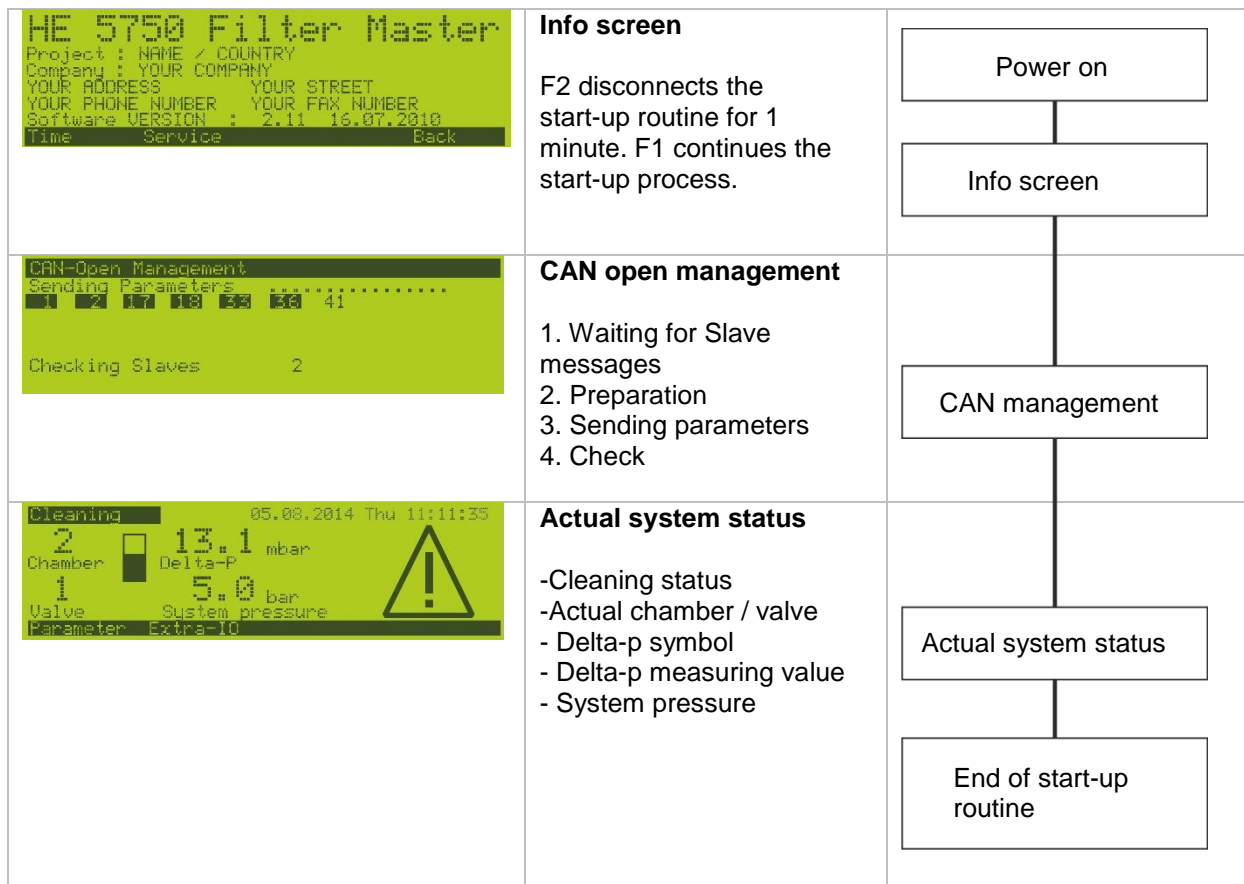

8 Display and operating elements

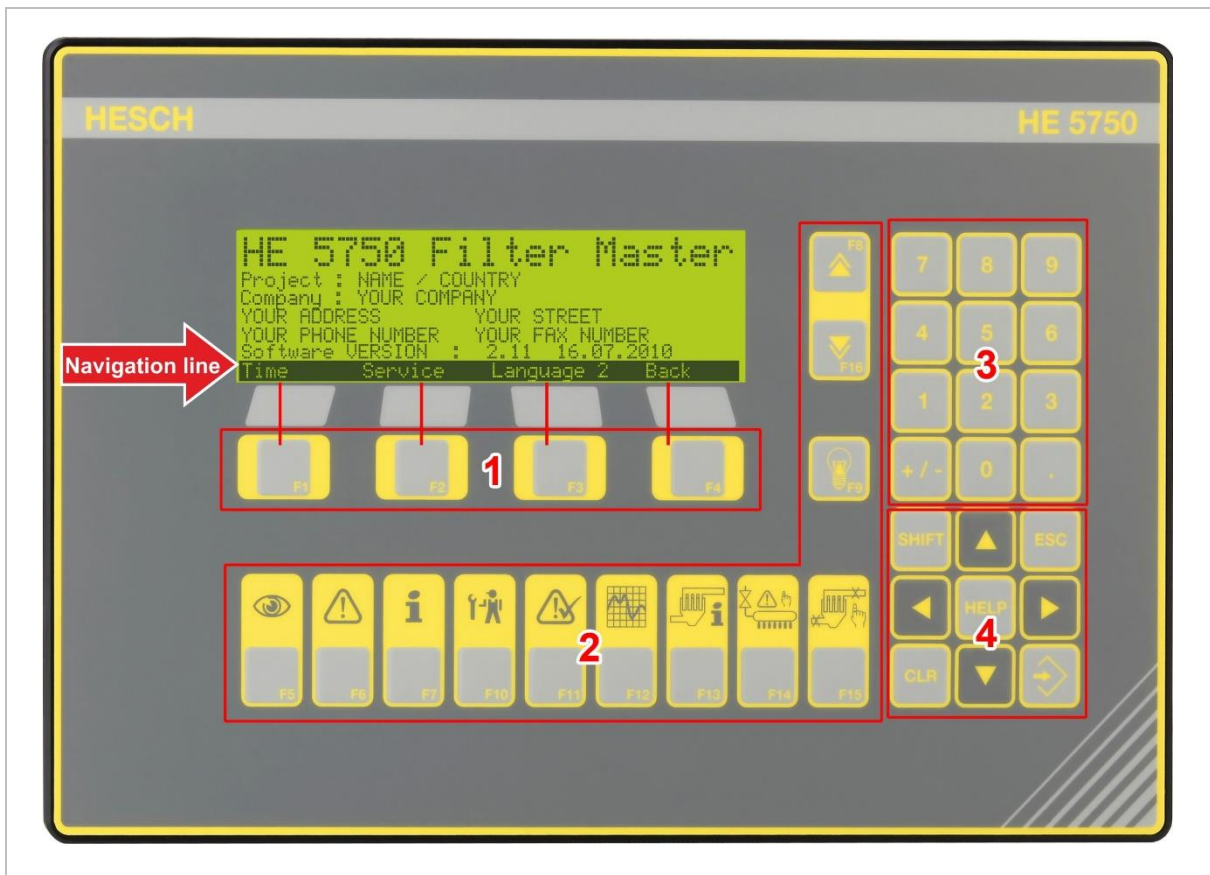

Figure 17. HE 5750 Display and operating elements

- 1 F1-F4 context keys
- 2 F5-F16 Fix function
- 3 Numeric keypad
- 4 Input block

8.1 Numeric keypad and input block



Additional functions, setting possibilities or branches are offered on the individual screens.

key	Function
	Press the ENTER key to accept an entry.
	Press the keys LEFT or RIGHT to change the decimal position or to navigate through the menu.
	Press the keys UP or DOWN to change the numeric value or to navigate through the menu. Values can also be entered via the numeric keypad (<i>pos. 3 in Figure 17</i>).
	Press the key ESC to quit an entry.
	These keys are without function.

8.2 Function keys F5-F16

These keys have different fix functions.

8.2.1 Actual system status F5

key	Function	Display
	After pressing the F5 key, the system status for cleaning and active alarms appear in the display.	
	After pressing the F5 key one more time, the system status for current dp thresholds is displayed.	

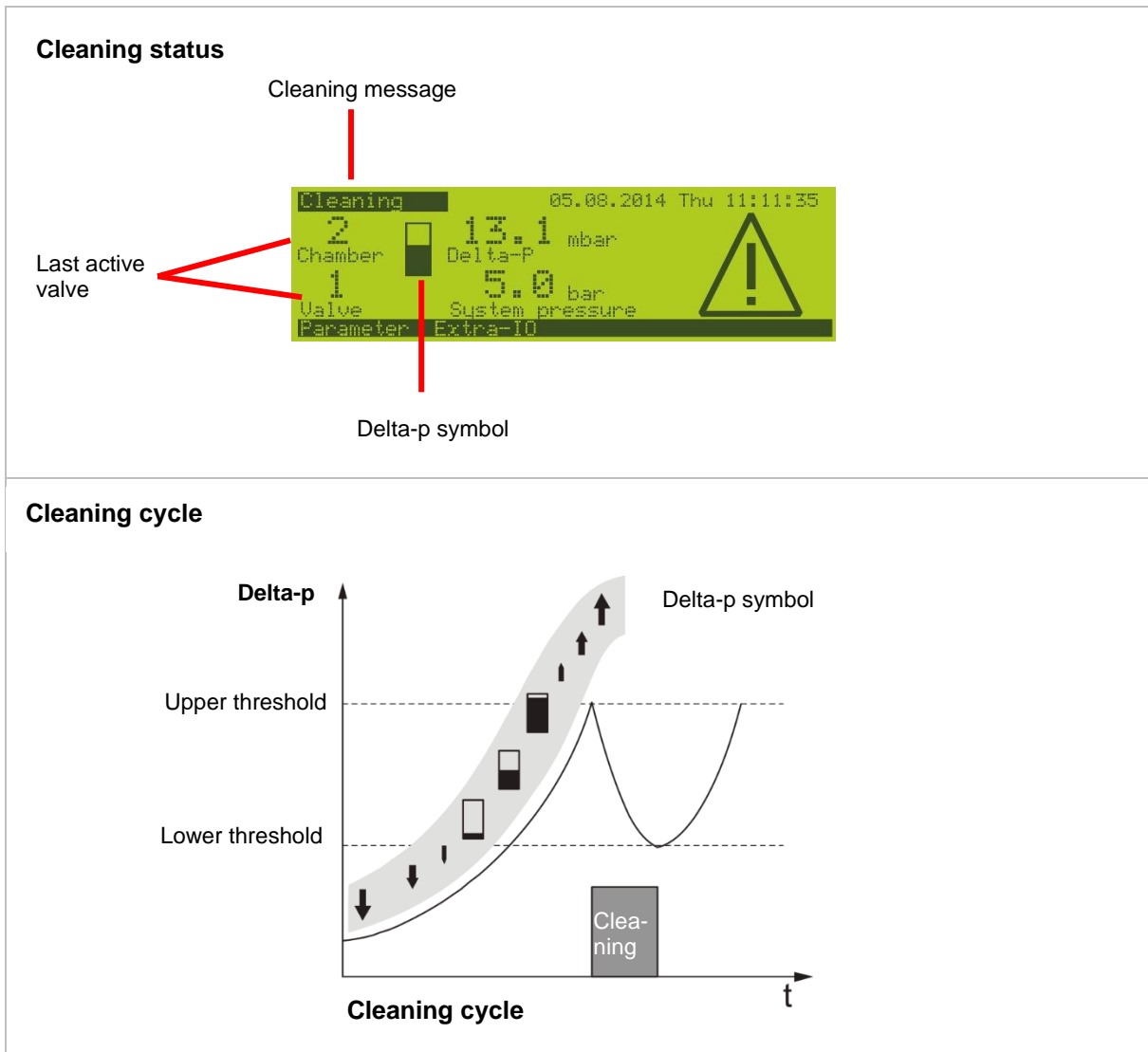



Figure 18. Cleaning status and cleaning cycle

Alarm triangle

The alarm triangle can be displayed in two different sizes.

<p>Large</p> <p>There are currently active alarms.</p>	
<p>Small</p> <p>There are alarms in hold position that are no longer applied.</p>	

Display settings

In this display the arrow keys have the following functions:

Keys (keep pressed!)	Function
	Reducing brightness
	Increasing brightness
	Reducing contrast
	Increasing contrast

8.2.2 Alarms F6

Key	Function	Display
	<ol style="list-style-type: none"> 1. Current Alarms 2. Alarm protocol Switch with F6	<pre> Actual alarms 2 : 15 HE5910 33 Bus-Error HE5910 36 Bus-Error System pressure low Ch. 1 Valve control. 2 Bus-Error Ch. 1 Manifold press. 1 Sensor break Ch. 2 Valve control 1 Bus-Error Back </pre>

8.2.3 Info screen F7

Key	Function	Display
	Project information. Can be adapted via SmartTool in text storage 260 to 269.	<pre> HE 5750 Filter Master Project : NAME / COUNTRY Company : YOUR COMPANY YOUR ADDRESS YOUR STREET YOUR PHONE NUMBER YOUR FAX NUMBER Software VERSION : 2.11 16.07.2010 Time Service Language 2 Back </pre>



8.2.4 Service screen F2

Key	Function	Display
	Press the service key F2 when Info screen is displayed, to indicate the service screen with operating hours and cleaning cycles.	<pre> HE 5750 Filter Master Project : NAME / COUNTRY Company : YOUR COMPANY YOUR ADDRESS YOUR STREET YOUR PHONE NUMBER YOUR FAX NUMBER Software VERSION : 2.11 16.07.2010 Time Service Language 2 Back </pre> <pre> Operating hours Control 392 h Maintenance free Cleaning 172 h Maintenance free Cleaning cycles 62104 Cycles Service Test Standby Back </pre>

8.2.5 Standby mode F3 (when operated with switch unit only)

Key	Function	Display
	Press the F3 key, when service screen is displayed. The switch unit switches the currently active HE 5750 Master controller into standby mode and activates the second HE 5750 as new Master controller (see <i>chapter 15.2 HE 5750 switch unit</i>).	<pre> Operating hours Control 392 h Maintenance free Cleaning 172 h Maintenance free Cleaning cycles 62104 Cycles Service Test Standby Back </pre>



8.2.6 Screen up / screen down keys F8 and F16

Key	Function	Display
	Screen up (F8) and screen down (F16) keys for the display. If more content is available then can be shown in the display, this indicated by two little arrows pointing downwards in the left bottom corner of the display.	

8.2.7 Lamp test F9

Key	Function	Display
	Indicator lights at the front door of the control cabinet are triggered.	The current display does not change.

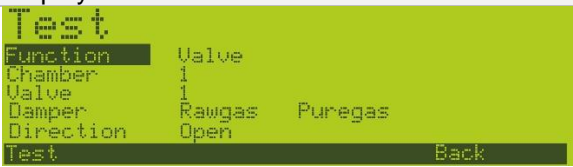
8.2.8 Test functions F10

Key	Function	Display
	Valve, isolation valve, dampers, chamber cleaning. Every single actuator can be triggered.	
	Navigation within the function with the arrow keys.	



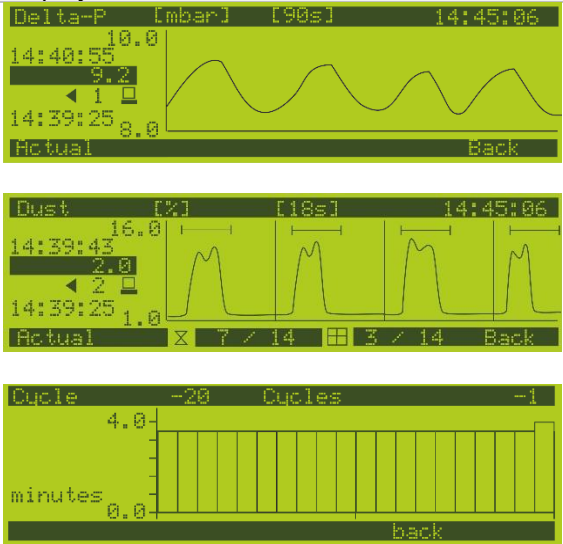

8.2.9 Acknowledging alarms F11

Key	Function	Display
	Current alarms are deleted. This key has the same function as the Alarm Acknowledge button installed at the control cabinet.	The current display does not change.

8.2.10 Graphic (Delta-p / dust development / filter cycle time) F12

Key	Function	Display
	<p>Delta-p, dust development and cycle time graphics have different time windows. By pressing the F12 key, one can switch between the graphics.</p>	

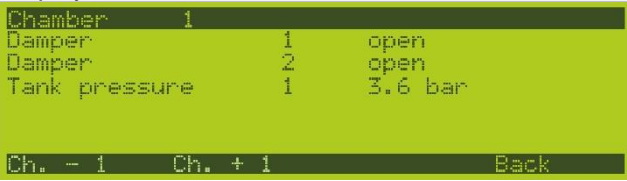
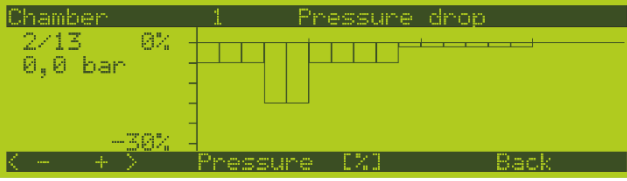
8.2.11 Chamber status F13

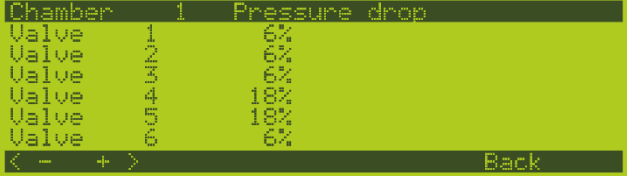
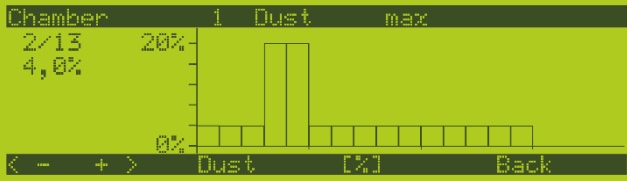
Key	Function	Display
	<p>Information is displayed chamber-related. Switching between the chambers with the arrow keys</p> <p></p> <p>Modification is not possible.</p>	
	<p>From this screen the pressure drop screen can be accessed by pressing F2. It provides information about the pressure drop in % for each valve, depending on the relative system pressure.</p>	
	<p>Pressing the F2 key once again calls up the tabular presentation on the screen. Navigation with F8 and F16 or with the arrow keys</p> <p></p>	
	<p>The dust sensor status is called up with F3. This status indicated the dust content in the clean gas line in %.</p>	

	Tabular presentation with F2 key.	<pre> Chamber 1 Dust [%] Valve 1 4% Valve 2 4% Valve 4 4% Valve 4 15% Valve 5 15% Valve 6 4% < - + > Back </pre>
--	-----------------------------------	-----------------------------------------------------------------------------------------------------------------------------------------------------------------------------------------------

8.2.12 Isolation valves F14

Key	Function	Display
	This function allows quick access to the isolation valves. In case the system blocks the isolation valves, they can be opened manually here.	<pre> Isolation valve Chamber 1-4 open open open open Isolation valve 2 open open open open toggle Back </pre>

8.2.13 Chamber isolation F15

Key	Function	Display
	Chambers are deleted from the cleaning process. The valves are not activated anymore. If available, dampers are closed.	<pre> Chamber Isolation Chamber 1-4 open open open open toggle Back </pre>





8.3 Context-sensitive keys F1-F4

Additional functions, setting possibilities or branches are offered on the individual screens. Some screens and functions can only be called up in special interactions. The bottom line (navigation line) in the various screens displays the available accesses and branches. The respective function is started by pressing the corresponding keys F1 to F4.







Figure 19. Context-sensitive keys F1-F4

During start-up



On	Hold		
			
Continues start-up for info screen without pause.	Displays the info screen for one more minute.		

Info screen F7











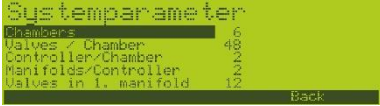

Time	Service	Language 1	Back
			
Setting time	Screen operating hours <u>Switching screens between:</u> <ul style="list-style-type: none"> • screen operating hours • analogue inputs • digital inputs • status Modbus communication • status Profibus communication by pressing the F8 / F16 key 	Switching between loaded languages Two languages can be loaded in the controller. If no second language is loaded, this selection is not offered.	Back

Alarm screen F6

Current alarms and alarm protocols are displayed. Switching display with F6 key.

Acknowledge			Back
			
Acknowledge alarm			Back

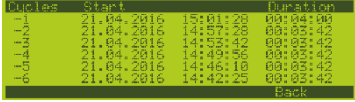
Current system status F5

Parameter	Extra I/O	Cycle
 <p>Access parameter menu</p>  <p>Navigation with F8 (screen UP) and F16 (screen DOWN) and arrow keys. Confirm the selection with ENTER key.</p>  <p>Navigation to the desired parameter. Pressing ENTER to edit the parameter.</p>  <p>Change the decimal position.</p>  <p>Change the value. Alternatively via numeric keypad.</p>  <p>Pressing ENTER to confirm the new value.</p>  <p>Pressing ESC cancels the input.</p>  <p>F4 key cancels the input and switches to previous level.</p>	 <p>Display of the Extra-I/O acc. to definition of the system parameters. The Extra-I/O can only be defined and parametrised via SmartTool.</p>	 <p>Display of filter cycle times can be called up in 2nd status screen.</p>  <p>Navigation through the list with arrow keys</p> 

8.4 Filter cycle times

The filter cycle time is the time required for a complete cleaning cycle across all chambers and valves.

Determination of cycle times:

A cleaning cycle usually starts with chamber 1, valve 1. This is also the case, if this valve cannot be triggered for some reason, e.g. a chamber isolation. At the moment of checking the valve status, the cycle change takes place. The counter of cleaning cycles is also increased. The cycle time determination is restarted. Power failure times during a cleaning cycle are not counted. In case of a power failure time of less than 4.5 days, the original start time of the cycle remains.

In addition, the start time is set to the time of power recovery. This also applies, when there is more than one power failure within one cycle.



Note!

In order to obtain a determination of cycle time beyond a power failure, it is necessary to set the parameter 'Autostart / Timeout-System status' to Current. Thus, the controller continues the cycle at the point of interruption after the power returns. Otherwise a new cycle starts.

The controller stores the cycle times internally for the last 100 cleaning cycles. The last 20 cleaning cycles can be displayed as table or as a bar diagram. The bar diagram can be called up via the F12 key. The table can be called up via the second system status F3 (cycle).

Via the process data pool (PDP) it is possible to transmit

- the last filter cycle time,
- the average value of the filter cycle time over the last 20 cycles,
- and the average value of the filter cycle time over the last 3 hours (max. 99 cycles)

into the distributed process control interface. This function can only be set via SmartTool!

At the same time an indication appears in the process data image of the controller. The cycle time is formatted as fixed point number in minutes with one position after decimal point.

Example:

Cycle time 37 => 3.7 minutes = 3 minutes und 7*6 seconds = 3:42 minutes

9 Parameter

9.1 Accessing parameter menu

Select the screen "Actual system status" by pressing F5. Afterwards press F1.

9.2 Parameter groups

1 System parameters	7 Chamber control	13 Malfunction monitor
2 Local operation	8 Operating hours	14 Dust monitoring (option)
3 Interfaces	9 Service	15 Cleaning factors
4 Valve controller	10 Autostart / Timeout	16 Delta-p control
5 Parallel valve	11 Passwords	17 Controller parameters
6 Cleaning cycle	12 Measurement ranges	18 Extra

The different parameters are described in chapters 9.4.1, 9.5.1, 9.6.1.

Parameters can be changed via:

- Controller keyboard
- Service-PC and software 'SmartTool'
- Process level

**Note!**

Operating instructions for 'SmartTool' can be ordered from HESCH.

9.3 Passwords

The parameter values are protected by four different password levels against unauthorised modification.

- 4 = HE5750 programme level
- 3 = Service system configuration system supplier
- 2 = customer (technician)
- 1 = customer

The following tables show the parameter values and the password levels.

9.4 Parameter table (parameter groups 1-6)

	Name	Default	Min	Max	Unit	Password	Level
1	System description						
1.1	Chambers	8	1	24		Service	3
1.2	Valves/chamber	16	1	64		Service	3
1.3	Slaves/chamber	1	1	2		Service	3
1.4	Valves on 1. Slave	16	1	32		Service	3
1.5	Manifolds/Controller	0	0	2		Service	3
1.6	Valves in 1. manifold	16	1	32		Service	3
1.7	Valve 1. manifold Sl. 2	16	1	32		Service	3
1.8	Dust detectors/chamber	0	0	2		Service	3
1.9	Isolation valves/Slaves	0	0	2		Service	3
1.10	Damper controller	0	0	1		Service	3
1.11	Hopper level	0	0	1		Service	3
2	Local operation						
2.1	Language	0 (Language 1)	0 (Language 1)	1 (Language 2)		Customer	1
2.2	Synchron. time	Off	-1 (0:00)	1439 (23:59)		Technician	2
3	Ports						
3.1	Interface PLC	1 (Profibus)	0 (Parallel)	3 (Modbus TCP)		Service	3
3.2	Modem Interface	0 (No)	0 (No)	1 (Yes)		Service	3
3.3	Baudrate COM 1	3 (9.)	0 (1.)	6 (57.)	kBaud	Technician	2
3.4	Device address	1	1	255		Technician	2
3.5	Baudrate COM 2	3 (9.6)	0 (1.2)	5 (38.4)	kBaud	Technician	2
3.6	Profibus Node-ID	12	1	125		Technician	2
3.7	Modbus parity	1 (No/2)	0 (No/1)	3 (Odd)		Technician	2
3.8	Redundancy mode	0 (No)	0 (No)	1 (Yes)		Service	3
4	Valve controller						
4.1	Operating mode	1 (threshold)	0 (permanent)	2 (control)		Technician	2
4.2	Cleaning mode	0 Part. cycle	0 Part. cycle	1 (Comp. cycle)		Technician	2
4.3	Manual cleaning mode	0 (permanent)	0 (permanent)	2 (control)		Technician	2
4.4	Valve sequence	1	1	31		Technician	2
4.5	Chamber sequence	1	0	23		Technician	2
4.6	1. Cycle time Pulse	100	10	60000	ms	Technician	2
4.7	1. Cycle time Pause	5.0	0.1	3600.0	s	Technician	2
4.8	2. Cycletime Pulse	0	0	60000	ms	Technician	2
4.9	2. Cycle time Pause	0	0	3600.0	s	Technician	2
4.10	Pressure switch funct.	0 (none)	0 (none)	7 (F+B+Z)		Technician	2
4.11	Manifold filling time	0 (No)	0 (No)	600.0	s	Technician	2
4.12	System pressure on	0 (No)	0 (No)	3600.0	s	Technician	2
4.13	System pressure off	1.0	1.0	3600.0	s	Technician	2
4.14	Drain valves	0	0	2		Technician	2
4.15	Drain valve pulse	100	10	60000	ms	Technician	2
4.16	Drain valve pause	60	1	10000	Minutes	Technician	2
4.17	Start/Stop function	0 (static)	0 (static)	2 (dynamic)		Technician	2
5	Parallel valves						
5.1	Parallel valve/chamber	0 (No)	0 (No)	1 (Yes)			2
5.2	Parallel chamber count	0 (No)	0 (No)	23		Technician	2
5.3	Parallel chamber 1, 2...24	0 (No)	0 (No)	24		Technician	2
6	Cleaning cycle						
6.1	Post-cleaning	1	0 (Off)	10	Cycles	Technician	2
6.2	Chamber cleaning	1	0 (Off)	10	Cycles	Technician	2
6.3	Background cleaning	0	0 (Off)	100		Technician	2
6.4	BG cleaning unit	0 (valves)	0 (valves)	2 (cycles)		Technician	2
6.5	BG cleaning time	0	0	1440.0	Minutes	Technician	2
6.6	BG cleaning threshold	2.0	0	900.0	mbar	Technician	2

9.4.1 Parameter description (parameter groups 1-6)



Note!

Make sure that the number of valves have been parametrised correctly. This means, for example, that no more valves can be distributed on the manifolds, than are assigned to the respective slave, otherwise malfunctions may occur.

For example, valves are not triggered correctly or alarm messages are shifted due to inconsistent distribution and do not apply to the current malfunction.



Note!

The assignment of manifolds is variable. For a system with two Slaves per chamber and three manifolds, set the number of manifolds to 2 per Slave. Depending on the number of valves in the first manifold and the valve number on the respective Slave, the first or the second Slave on a manifold can be reduced, if all valves are assigned to the first manifold.

Parameter	Description
1 System description	Parameter block for the description of the filter setup.
1.1 Chambers	Number of chambers in a filter.
1.2 Valves / chamber	Number of valves per chamber. Correct value is absolutely necessary for flawless function of the control process.
1.3 Slaves / chamber	Slave boxes per chamber Each Slave box controls 32 valves maximum. In case of more than 32 valves per chamber, a second Slave box is necessary.
1.4 Valves on 1. Slave	If the system has two slaves per chamber, this parameter controls the distribution of the valves on Slave 1 and Slave 2.
1.5 Manifolds / Slave	The valve controller (Slave Box) can switch off the air pressure of a local manifold with an isolation valve, especially if 2 manifolds are used. With the function "valve monitoring", one Slave box can monitor the pressure in two manifolds. For this purpose, the pressure curve during valve triggering is measured. The pressure drop during valve triggering and the pressure increase afterwards must reach certain values to avoid that a valve error is recorded. The values can be adjusted with parameter 13.6 Pressure drop.
1.6 Valves in 1. manifold (on 1st Slave)	The number of valves for one manifold. In case of two manifolds, the number of valves according to manifold distribution. If two manifolds per Slave box are used and the distribution is not even, this parameter indicates the number of valves in the first manifold. This information is used to select the correct pressure transmitter for valve controlling. The parameter has no significance without the valve controlling function.
1.7 valves 1. manifold Sl. 2	If the system has two slaves per chamber, this parameter controls the distribution of the valves on the manifolds for the second Slave.
1.8 Dust detectors / chamber	Dust detectors monitor the filter outlet, the pure gas side. Dust detectors can be e.g. measuring transducers with a constant output signal of 4...20 mA or limit switches with switch contact.. The voltage supply of the dust sensor can be selected on the Slave box. The Slave box parameter is different for analogue or switch sensors. The first Slave box can evaluate two dust sensors. The dust sensors may be of different types (analogue value or switch sensor). The signals are handled internally as 'Switched OR'.
1.9 Isolation valves / Slave	A valve controller can switch two isolation valves for 2 manifolds.

Parameter	Description
1.10 Damper controller	One damper controller monitors the pure gas dampers of up to 8 chambers. Another damper controller monitors the raw gas dampers. This parameter determines whether a damper control is carried out. The damper controller boxes also transfer some analogue measuring values. The pure gas node measures 3 input temperatures (displayed with F5) and the Delta-p value. The raw gas node also measures the hopper level. The damper controller is described more detailed in 7 Chamber control.
1.11 Hopper level	Determines whether the system is supposed to control hopper levels or not. If 'Yes', the Master controller initialises and monitors the respective digital inputs in the raw gas damper controllers. Another parameter determines which action is performed if level 'high' is detected.
2 Local operation	
2.1 Language	Language 1, language 2 All display texts can be indicated in two languages. The language elements are stored in a non-volatile part of the memory. The controller itself operates independently from the language with internal text numbers. Each text number represents a word or a phrase. The current language is selected with this parameter. For this purpose, the language set must be loaded. The complete text list must be loaded in the controller to be available. Switching the language can easily be done with the function keys: Press info key F7 and then switch to the other language with F3.
2.2 Synchron. time	A signal from the process control sets the controller clock to the time value set here. The signal can be sent via the serial communication or via the parallel interface.
3 Interfaces	
3.1 PLC interface (process control)	The interface used between process control (PLC) and this controller. Three interfaces are available between process control and Master controller. 'Classical type' as contact interface. The contacts are realised on the basis of the modular input/output system. 'PROFIBUS-DP' as fieldbus interface. With Profibus a complete system image is possible. A modification of the parameters via profibus is not possible at present. 'Modbus' communication via RS485 <u>The controller offers three interfaces:</u> 'CAN bus' is the internal bus system for the valve controllers, the damper controllers and the parallel interface box. 'PROFIBUS' is the standard interface to the process control. 'PROFIBUS' interface is independent from the other serial interfaces 'RS 232' and 'RS 485' are the standard interface for service and modem control.
3.2 Modem Interface	RS 232 is the only way for modem connection. A Hayes compatible basic control set is used for the modem control.
3.3 Baud rate COM1 (RS232)	If the modem was selected, COM1 is automatically used with 9.6 kbaud, even if the parameter has another value.

Parameter	Description
3.8 Redundancy mode	<p>If redundancy mode is active, the following modifications and functions occur: The local input/output pair DO6, IN8 (inverted Toggle signal) is used for the digital interface to the switch module:</p> <ul style="list-style-type: none"> • DO6: 0=>1 giving control to the other controller unit • IN8: 0=Active, 1=Standby <p>If redundancy mode = 'yes', then</p> <ul style="list-style-type: none"> • the 'modem interface' is internally deactivated • and the baud rate COM1 is internally set back to 57.6 kBaud <p><u>In 'Standby' mode:</u></p> <ul style="list-style-type: none"> • the local operation on the display is locked. The display now shows Standby instead of Remote and the controller is also held in emergency stop mode. • alarms are suppressed • The local status outputs like 'Operation', 'Cleaning', 'Error', 'pulse signal', 'central isolation valve' and 'dp-cleaning signal' are switched off. • No process commands are accepted via the process control interface, except for: Toggle Bit for checking the communication with process control
4 Valve controller	
4.1 Operation mode	<p>Sets the Start / Stop condition of the cleaning process. Requirement: The wiring of the inputs 'Filter Start', 'Filter Stop' etc. have been done correctly.</p> <p>'Permanent' -> Start/Stop depend on the connection of the inputs.</p> <p>'Threshold' -> Start/Stop depends on the connection of the inputs and dp-signal (threshold is defined by special parameters).</p> <p>'Control' -> control according to a flow rate rated dp signal. The relationship between dp signal and flow rate can be defined with a curve with 10 coordination pairs.</p>
4.2 Cleaning mode	Setting that defines whether the cleaning process is done with entire cycles or with partial cycles.
4.3 Manual cleaning mode	<p>Defines the Start / Stop condition of the manual cleaning mode.</p> <p>'Permanent' -> Start/Stop only depends on the input connection.</p> <p>'dp threshold' -> Start/Stop depends on the connection of the inputs and dp signal (threshold is defined by special parameters).</p> <p>'Control' -> control according to a flow rate rated dp signal. The relationship between dp signal and flow rate can be defined with a curve with 10 coordination pairs.</p>
4.4 Valve sequence	Increment amount for calculating the next active valve within a chamber.
4.5 Chamber sequence	Increment amount for calculating the next active chamber.
4.6 1st Cycle time pulse	<p>Pulse time for the first set of control times. This pulse time is used for the regular cleaning process.</p>
4.7 1st Cycle time pause	<p>Pause time for the first set of control times. This pause time is used for the regular cleaning process.</p>
4.8 2nd Cycle time pulse	<p>Pulse time for the second set of control times. This pulse time is used for 'BG cleaning', 'manual cleaning' and 'post cleaning'. If 0 is entered here, the pulse time of the first set is used.</p>
4.9 2nd Cycle time pause	<p>Pause time for the second set of control times. This pause time is used for 'BG cleaning', 'manual cleaning' and 'post cleaning'. If 0 is entered here, the pause time of the first set is used.</p>

Parameter	Description
4.10 Pressure switch function	<p>By using a pressure transmitter in a manifold, three functions (incl. their combinations) can be selected.</p> <p>'Valve function' -> After a valve has been triggered, the pressure must fall below a certain value. If not, an error message is generated. After closing the valve, the pressure must exceed a certain value. If not, the isolation valve of the manifold is closed and an error message generated. The thresholds are defined by separate parameters.</p> <p>'Pressure' -> before a valve has been triggered, the pressure in the respective manifold must be above a certain value. If not, the valve is not triggered and an error message is generated. The value is defined by a separate parameter.</p> <p>'Pause Time optimisation' -> The possibility to reduce the pause time between two valve triggers when the pressure at the local manifold has regenerated. The pause time in the above parameters is understood as max. time that can be reduced by an early regeneration of the manifold pressure. The threshold therefore is set with parameter 13.5 'Minimum Pressure in Manifold'.</p>
4.11 Manifold filling time	Monitoring of the pressure starts after the filling time of the manifold ends, because the manifold needs a certain time after opening the isolation valve to generate the operating pressure. If the filling time is exceeded, a 'Valve Does Not Close' error is assumed.
4.12 System pressure on	The lead time after opening the central isolation valve and further actions. Triggers the central isolation valve
4.13 System pressure off	Follow-up time for closing the central isolation valve
4.14 Drain valves	Number of drain valves per valve Slave box. 0 = drain valves off Valves of two manifolds can be connected to one valve box. <u>Connection sequence at the valve terminals with 2 manifolds:</u> Blowing valves manifold 1, blowing valves manifold 2, drain valve manifold 1, drain valve manifold 2
4.15 Drain valve pulse	Opening period of a drain valve.
4.16 Drain valve pause	Pause to next activation of the same drain valve
4.17 Start / Stop function	The command mode from the process control (permanent signal, sensor signal). The condition of the controller is reported.
5 Parallel valves	<p>The system can trigger 2 chambers at the same time. Each chamber that should be triggered at the same time has its own parameter. Condition: chambers to be triggered at the same time are not connected to the same valve controller. Each chamber is only triggered once per cycle.</p> <hr/> <div style="display: flex; align-items: center;">  <div> <p>Note! A parametrised parallel cleaning can be temporarily suppressed via the master controller interface!</p> </div> </div> <hr/>
5.1 Parallel valve / chamber	For systems with 2 slaves per chamber, the valves of one chamber can be triggered simultaneously by both Slaves, and the valves within a chamber can be cleaned in parallel. For this purpose, the first slave must have precisely as many valves assigned to it or one more valve, than are assigned to the second Slave (<i>See parameters 1.4 Valve on 1st Slave*</i>). If this assignment is not complied with, it is possible that <u>not all</u> valves are cleaned.
5.2 Parallel chambers	With a continuous linking of the parallel chambers (parameter parallel chambers 1...24) the maximum number of parallel chambers is limited.

Parameter	Description
5.3 Parallel chamber 1,2... 24	For each chamber, a parallel chamber can be determined which is supposed to be cleaned. Example: Parallel chamber 1 with value 10: Chamber 1 and chamber 10 are triggered in parallel per cycle.
6 Cleaning cycle (Cleaning process)	
6.1 Post cleaning	Post cleaning is a cleaning procedure that includes all valves of the filter system. Up to 10 repetitions of these cleaning cycles can be selected. Post cleaning is started by the post cleaning input and uses pulse and pause time of the second control time set.
6.2 Chamber cleaning	Chamber cleaning is the cleaning of all valves in a chamber. Up to 10 repetitions of chamber cleaning can be selected.
6.3 Background cleaning	With very low differential pressure the background cleaning monitors the time that has passed since the last valve triggering. This is useful for the small flow rate, which nevertheless generates a dust entry in the filter system. If no valve triggering took place within the background cleaning time, background cleaning starts with times of the second controller times set.
6.4 Background cleaning unit	The parameter specifies what should be cleaned during the background cleaning.
6.5 Background cleaning time	Max. time between 2 valve triggerings. If the time is exceeded, the controller starts the background cleaning.
6.6 Background cleaning threshold	A value close to zero. If the delta-p value is even smaller, it is assumed that the system is switched off and no background cleaning takes place.

9.5 Parameter table (parameter groups 7-12)

	Name	Default	Min	Max	Unit	Password	Level
7	Chamber control						
7.1	Raw gas dampers / chamber	1	0	2		Service	3
7.2	Pure gas dampers / chamber	1	0	2		Service	3
7.3	Chamber input level	2 (high)	0 (No)	2 (high)		Service	3
7.4	Chamber output level	1 (high)	0 (low)	1 (high)		Service	3
7.5	Damper limit level	1 (high)	0 (low)	1 (high)		Service	3
7.6	Damper Offline-Clean.	2 (pure gas)	1 (raw gas)	3 (all)		Service	3
7.7	Semi-Offline-Cleaning	0 (No)	0 (No)	2 (true)		Service	3
7.8	Damper control time	10	1	3600	s	Service	3
7.9	Cleaning delay time	10	0	3600	s	Service	3
7.10	Chamber delay time	10	0	3600	s	Service	3
7.11	Abrasion time	0 (Off)	0	3600	s	Service	3
7.12	Chamber post cleaning	0 (Off)	0	10	Cycles	Service	3
7.13	Hopper level monitor.	0 (Switch off)	0 (Switch off)	1 (close)		Service	3
7.14	Hopper level delay	30.0	0	1440.0	Minutes	Service	3
7.15	Hopper level rise	10.0	0	600.0	s	Service	3
7.16	Hopper level fall	10.0	0	600.0	s	Service	3
7.17	Manifold pres. monitor	0 (Switch off)	0 (Switch off)	1 (close)		Service	3
7.18	Chamber isolation auto	0	0	24	Chambers	Service	3
7.19	Damper movement	0	0	1000	days	Service	3
7.20	Chamber status message	0 (Switch off)	0 (Switch off)	1 (Limit level)		Service	3
8	Operating hours						
8.1	Control	0	0	1000000	h	HE5750	4
8.2	Cleaning	0	0	1000000	h	HE5750	4
8.3	Cleaning cycles	0	0	1000000	Cycles	HE5750	4
8.4	Service Controller	0	0	1000000	h	HE5750	4
8.5	Service cleaning	0	0	1000000	h	HE5750	4
8.6	Service Clean. cycles	0	0	1000000	Cycles	HE5750	4
9	Service						
9.1	Period Controller	0 (Off)	0 (Off)	99999	h	Service	3
9.2	Period Cleaning	0 (Off)	0 (Off)	99999	h	Service	3
9.3	Period Cycles	0 (Off)	0 (Off)	99999	Cycles	Service	3
10	Autostart / Timeout						
10.1	System state 0	0 (Default)	0 (Default)	1 (Actual)		Technician	2
10.2	System timeout	0 (Off)	0 (Off)	1440.0	Minutes	Technician	2
10.3	Autostart delay	0 (Off)	0 (Off)	1440.0	Minutes	Technician	2
10.4	Remote timeout	0 (Off)	0 (Off)	1440.0	Minutes	Technician	2
10.5	Local timeout	0 (Off)	0 (Off)	1440.0	Minutes	Technician	2
11	Passwords						
11.1	HE5750	10000	10000	39999		HE5750	4
11.2	Service	0	0	9999		Service	3
11.3	Customer (technician)	0	0	9999		Technician	2
11.4	Customer	0	0	9999		Customer	1
12	Measurement ranges						
12.1	Delta-p unit	0	0	1		Technician	2
12.2	Delta-p	30.0	9.9 (No)	900.0	mbar	Technician	2
12.3	Flow rate	0	0 (No)	9000	km3/h	Technician	2
12.4	Pressure	10.0	0.9 (No)	900.0	bar	Technician	2
12.5	Dust	100	49 (No)	200	%	Technician	2
12.6	Delta-p Filter	0 (Off)	0 (Off)	999	s	Technician	2
12.7	Flow rate filter	0 (Off)	0 (Off)	999	s	Technician	2
12.8	Dust filter	0 (Off)	0 (Off)	99.9	s	Technician	2

9.5.1 Parameter description (parameter groups 7-12)

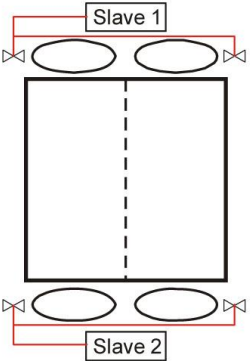
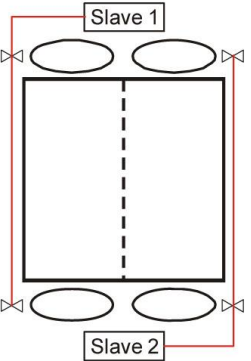
Parameter	Description
7 Chamber control	<p>Online: In the Online mode the chambers are cleaned with opened raw gas and pure gas dampers.</p> <p>Offline: Only entire chambers are cleaned in the Offline mode. Therefore, the raw gas dampers and / or pure gas dampers are closed before cleaning and are afterwards opened (<i>parameter 7.6 Damper offline cleaning</i>).</p>
7.1 Raw gas dampers / chamber	Number of raw gas dampers per chamber.
7.2 Pure gas dampers / chamber	Number of pure gas dampers per chamber.
7.3 Chamber cleaning (level)	(Function not implemented) Signal level for the input for chamber isolation 0=low 2= high
7.4 Chamber output (level)	Signal level for closing the dampers (Pure gas dampers / raw gas dampers) 0=low 1=high
7.5 Damper limit level	The signal level by which the dampers report their limit level. High: the limit level of the damper is reported with high level (+24 V). 0=low 1=high
7.6 Damper Offline Cleaning	For the Offline cleaning the closed damper can be selected. This may be the raw gas or the pure gas damper or both.
7.7 Semi-Offline-Cleaning	<hr/> <div style="display: flex; align-items: flex-start;"> <div style="margin-right: 10px;">  </div> <div> <p>Note! <u>To guarantee the Semi-Offline cleaning, the following conditions must be fulfilled:</u></p> <ul style="list-style-type: none"> ✓ The first and second Slave must have the same amount of valves assigned. One additional valve may be assigned to the first Slave. ✓ The amount of valves in the first manifold must be equal to the amount of valves in the first manifold on the second Slave. Valve in 1. Manifold = valve in 1. manifold SI.2) </div> </div> <hr/> <p>Depending on the wiring of the isolation valves at the local pressure manifolds.</p> <div style="display: flex; justify-content: space-around; align-items: center;"> <div style="text-align: center;">  </div> <div style="text-align: center;">  </div> </div> <p>1 Virtual Semi-Offline - Mode 2. True Semi-Offline - Mode</p>

Parameter	Description
7.8 Damper control time	Max. closing time and max. opening time for monitoring the dampers. The error message 'Chamber Disturbance' is reported, if the times are exceeded.
7.9 Cleaning delay time	During offline cleaning a cleaning delay time can be set between the cleaning and the opening of the dampers. This 'delay prior to opening' allows the dust to set.
7.10 Chamber delay time	After the opening of a damper a chamber delay time is allowed. During this time, the differential pressure, which increases by closing a chamber and reduces opening, can regenerate.
7.11 Abrasion time	Opening and closing a damper with dust in the medium leads to abrasion. Therefore the damper on the pure gas side is used for the active switch-off and switch-on of the gas flow. Switch off: Pure gas damper closes, waiting time, raw gas damper closes. Switch on: Raw gas damper opens, waiting time, pure gas damper opens.
7.12 Chamber post cleaning	The number of post cleanings per chamber can be selected. The parameter 'Chamber Offline Cleaning' must be set first. If the conditions are fulfilled and the chamber is closed, the controller sequentially triggers all valves of the chamber. The cleaning process is continued until the number of set cycles is achieved.
7.13 Hopper level monitoring	Defines the procedure, if the hopper level is high. Switch-off: no further cleaning of this chamber. Closing: no further cleaning and closing of the dampers.
7.14 Hopper level delay	Delay time between the 'Hopper High Signal' and the action as defined in 6.13. Allows time for the service staff to inspect the filter.
7.15 Hopper level rise	A delay time between the signal of the hopper level sensor and the 'Hopper Level High' message. Allows time for the persons in charge to work off peak-loads.
7.16 Hopper level fall	Minimum time required for 'Hopper Level High' message. Both delay times regenerate the 'Hopper Level High' message.
7.17 Manifold pressure monitor	Defines the procedure, if the hopper level is low. Switch-off: no further cleaning of this chamber. Closing: no further cleaning and closing of the dampers.
7.18 Chamber isolation auto	Number of chambers, which can be closed automatically. Example: 6 chamber system, 1 chamber closed manually Parameter 7.18 = 3 → 2 chambers can be closed automatically still.
7.19 Damper movement	The times of the damper movement are recorded. The damper is triggered considerably before reaching the limit level in order not to affect the filter pressure. Function not yet implemented.
7.20 Chamber state message	During 'Switch-off', the cleaning state of the chamber is reported. The condition of existing dampers is reported.
8 Operating hours	
8.1 Control	A counter for the real operating time of the controller. The times are stored internally with the real time.
8.2 Cleaning	A counter for the real cleaning time.
8.3 Cleaning cycles	A counter for the real cleaning cycles.
8.4 Service Controller	A down-counter for the next maintenance.
8.5 Service Cleaning	A down-counter for the next maintenance.
8.6 Service Cleaning cycles	A down-counter for the next maintenance. Service on fans, filter hoses, dust sensors, pressure tubes, manifolds etc.
9 Service	
9.1 Period Controller	Setpoint value for the service period. The current counter can be retrieved during the operating time. If the performance of the service measures is confirmed, the down-counter is re-filled with this setpoint.
9.2 Period Controller	Period for the service related to the cleaning time.
9.3 Period Cycles	Period for the service related to the cleaning cycles.
10 Autostart / Timeout	
10.1 System start	Default causes the system to restart without history. 'Actual' takes over the operation of the most recently saved position.

Parameter	Description
10.2 System timeout	A value to differentiate between an isolated and a short interruption of the voltage supply. Short interruption: continues the operation at the saved position. Switch off: System restart
10.3 Autostart delay	Delay time between switching-on and the start of the AUTO performance, which provides the operator and the process system with the possibility to enter an input at the controller.
10.4 Remote timeout	The controller keys can be deactivated via the process level, via modem or via PC command. After this time the controller keys are released again, in case the process level fails.
10.5 Local timeout	The local keys at the control cabinet are released again, in case they were deactivated.
11 Passwords	Access to the parameters is regulated by a system of different service levels. Everybody can see each parameter, however a password is required to modify protected parameters. After entering the password the parameters of this service level can be modified. By the presentation of the default operating display, access to the parameters is cancelled again.
11.1 HE 5750	System engineering and setup, all parameters
11.2 Service	Service staff of manufacturer.
11.3 Customer (technician)	Service staff of customer.
11.4 Customer	Operating staff of customer.
12 Measurement ranges	Since the controller receives analogue values only in nominated form (4 to 20mA, measurement ranges and physical units must be defined in order to be presented correctly.
12.1 Delta-p unit	1 milli bar = 10.197 mm water column 1 mm WG = 0.098 milli bar
12.2 Delta-p	20mA correspond to the entered value
12.3 flow rate	1 k m ³ /h = 1000 m ³ /h = 277.7 ltr/s = 73.38 US gal/s.
12.4 Pressure	The measuring range of all pressure transmitters.
12.6 Delta-p filter	The process signal is equipped with a low-pass filter first order. This value is displayed and internally processed.
12.7 Volume flow filter	The process signal is equipped with a low-pass filter first order. This value is displayed and internally processed. For the signal exchange, the user can select whether the filtered value (process value) or the unfiltered value (field value) is transmitted.
12.8 Dust filter	The process signal is equipped with a low-pass filter first order. This value is displayed and internally processed.

9.6 Parameter table (parameter groups 13-19)

	Name	Default	Min	Max	Unit	Password	Level
13	13 Malfunction monitor						
13.1	Delta-p Low Alarm	-5.0	-10.0	900.0	mbar	Technician	2
13.2	Delta-p High Alarm 1	20.0	-10.0	900.0	mbar	Technician	2
13.3	Delta-p High Alarm 2	25.0	-10.0	900.0	mbar	Technician	2
13.4	Pressure High Alarm	10.0	1.0	900.0	bar	Technician	2
13.5	Minimum pressure	50	0	100	%	Technician	2
13.6	Pressure drop	-30	-100	100	%	Technician	2
13.7	Lock manifold	0 (No)	0 (No)	1 (Yes)		Technician	2
13.8	Dust increase	50	-100	100	%	Technician	2
13.9	Dust monitoring mode	0 (act. Pulse)	0 (act. Pulse)	1 (permanent)		Technician	2
13.10	Dust delay	1.0	0	3600.0	s	Technician	2
13.11	Valve current	0.1 (Off)	0.1 (Off)	1.0	A	Technician	2
13.12	Odd valve count	0 (No)	0 (No)	3		Technician	2
13.13	Hold function	0 (No)	0 (No)	1 (Yes)		Technician	2
13.14	Fail-safe	0 (No)	0 (No)	1 (Yes)		Technician	2
14	Dust monitoring (OPTION!) - See chapter 15.1.1 -						
14.1	Central dust sensor	0 (No)	0 (No)	3		Technician	2
14.2	Dust alarm max.	50.0	0.0	200.0	%	Technician	2
14.3	Dust alarm relative	0	0	1		Technician	2
14.4	Dust pre-alarm	20.0	0.0	500.0	%	Technician	2
14.5	Dust main-alarm	30.0	0.0	500.0	%	Technician	2
14.6	Dust check time	2.0	0.1	10.0	s	Technician	2
14.7	Dust alarm filter	0.1	0.1	10.0	s	Technician	2
14.8	Dust sensor dead time	0.0	0.0	10.0	s	Technician	2
14.9	Dust valve lock	0	0	3		Technician	2
14.10	Dust chart hold	9	0	200	s	Technician	2
14.11	Gas velocity max.	5.0	0.1	100.0	m/s	Technician	2
14.12	Distance chamber 1	0.0	0.0	500.0	m	Technician	2
14.13	Distance chamber 2	0.0	0.0	500.0	m	Technician	2
14.14	Distance chamber 3	0.0	0.0	500.0	m	Technician	2
14.15	Distance chamber 4	0.0	0.0	500.0	m	Technician	2
14.16	Distance chamber 5	0.0	0.0	500.0	m	Technician	2
14.17	Distance chamber 6	0.0	0.0	500.0	m	Technician	2
14.18	Distance chamber 7	0.0	0.0	500.0	m	Technician	2
14.19	Distance chamber 8	0.0	0.0	500.0	m	Technician	2
14.20	Distance chamber 9	0.0	0.0	500.0	m	Technician	2
14.21	Distance chamber 10	0.0	0.0	500.0	m	Technician	2
14.22	Distance chamber 11	0.0	0.0	500.0	m	Technician	2
14.23	Distance chamber 12	0.0	0.0	500.0	m	Technician	2
14.24	Distance chamber 13	0.0	0.0	500.0	m	Technician	2
14.25	Distance chamber 14	0.0	0.0	500.0	m	Technician	2
14.26	Distance chamber 15	0.0	0.0	500.0	m	Technician	2
14.27	Distance chamber 16	0.0	0.0	500.0	m	Technician	2
14.28	Distance chamber 17	0.0	0.0	500.0	m	Technician	2
14.29	Distance chamber 18	0.0	0.0	500.0	m	Technician	2
14.30	Distance chamber 19	0.0	0.0	500.0	m	Technician	2
14.31	Distance chamber 20	0.0	0.0	500.0	m	Technician	2
14.32	Distance chamber 21	0.0	0.0	500.0	m	Technician	2
14.33	Distance chamber 22	0.0	0.0	500.0	m	Technician	2
14.34	Distance chamber 23	0.0	0.0	500.0	m	Technician	2
14.35	Distance chamber 24	0.0	0.0	500.0	m	Technician	2
15	Cleaning factors						
15.1	Chamber division	0 (Off)	0 (Off)	8		Technician	2
15.2	Cleaning factor 1	100	10	1000	%	Technician	2
15.3	Cleaning factor 2	100	10	1000	%	Technician	2
15.4	Cleaning factor 3	100	10	1000	%	Technician	2
15.5	Cleaning factor 4	100	10	1000	%	Technician	2
	...						
15.49	Cleaning factor 48	100	10	1000	%	Technician	2
16	Pre-pressure control						
16.1	Type of control	0 (Off)	0 (Off)	3 (ext. nominal value)		Technician	2
16.2	Type of valves	0 (NC)	0 (NC)	2 (control valve)		Technician	2

	Name	Default	Min	Max	Unit	Password	Level
16.3	Pressure regulation valve	0	0	900.0	bar	Technician	2
16.4	Filter resistance 20%	0	0	900.0	mbar	Technician	2
16.5	Filter resistance 80%	0	0	900.0	mbar	Technician	2
16.6	Setpoint 0%	0	0	900.0	bar	Technician	2
16.7	Setpoint 10%	0	0	900.0	bar	Technician	2
16.8	Setpoint 20%	0	0	900.0	bar	Technician	2
16.9	Setpoint 30%	0	0	900.0	bar	Technician	2
16.10	Setpoint 40%	0	0	900.0	bar	Technician	2
16.11	Setpoint 50%	0	0	900.0	bar	Technician	2
16.12	Setpoint 60%	0	0	900.0	bar	Technician	2
16.13	Setpoint 70%	0	0	900.0	bar	Technician	2
16.14	Setpoint 80%	0	0	900.0	bar	Technician	2
16.15	Setpoint 90%	0	0	900.0	bar	Technician	2
16.16	Setpoint 100%	0	0	900.0	bar	Technician	2
17	dp-control						
17.1	Lower threshold	10.0	0	900.0	mbar	Technician	2
17.2	Upper threshold	15.0	0	900.0	mbar	Technician	2
17.3	Dp-Offset	0	-900.0	900.0	mbar	Technician	2
17.4	Setpoint 0%	0	0	900.0	mbar	Technician	2
17.5	Setpoint 10%	0	0	900.0	mbar	Technician	2
17.6	Setpoint 20%	0	0	900.0	mbar	Technician	2
17.7	Setpoint 30%	0	0	900.0	mbar	Technician	2
17.8	Setpoint 40%	0	0	900.0	mbar	Technician	2
17.9	Setpoint 50%	0	0	900.0	mbar	Technician	2
17.10	Setpoint 60%	0	0	900.0	mbar	Technician	2
17.11	Setpoint 70%	0	0	900.0	mbar	Technician	2
17.12	Setpoint 80%	0	0	900.0	mbar	Technician	2
17.13	Setpoint 90%	0	0	900.0	mbar	Technician	2
17.14	Setpoint 100%	0	0	900.0	mbar	Technician	2
18	Controller settings						
18.1	Maximum Pause	600	10	3600	s	Technician	2
18.2	P-part	10	0	999.9	%	Technician	2
18.3	I-part	100	1	999.9	s	Technician	2
18.4	D-part	0	0	999.9	s	Technician	2
18.5	Dt1-part	0	0	999.9	s	Technician	2
18.6	Proportional pause	10	0	100	%	Technician	2
18.7	Controller modificat.	100	0	200	%	Technician	2
18.8	Controller maximum	250	0	900.0	mbar	Technician	2
19	Extra -Only via 'SmartTool'						
19.1	LCD contrast	50	5	100	%	Customer	1
19.2	LCD brightness	70	5	100	%	Customer	1

9.6.1 Parameter description (parameter groups 13-19)

Parameter	Description
13 Malfunction monitor	
13.1 Delta-p Low Alarm	Negative values stand for a reversed air flow. The sensor must be able to provide negative values for this function.
13.2 Delta-p High Alarm 1	Pressure threshold for Delta-p Alarm 1
13.3 Delta-p High Alarm 2	Pressure threshold for Delta-p Alarm 2
13.4 Pressure High Alarm	System Pressure High Alarm
13.5 Minimum pressure	Pressure in the local manifold compared to system pressure, which is mandatory for the valve triggering.
13.6 Pressure drop	The pressure drop after a valve triggering is normal and is evaluated to monitor the proper operation. Positive: an absolute pressure drop related to the system pressure Negative: a relative pressure drop related to the pressure prior to the valve triggering.
13.7 Lock manifold	Yes: during 'System Pressure Low' the manifolds are locked.
13.8 Dust increase	Positive values stand for the absolute dust level of the sensor. Negative values stand for the dust increase within a certain time and ignore the increasing contamination of the sensor. 0 = dust signal as switch contact.
13.9 Dust monitoring type	<p>The 'Dust too High' message can be linked to the pulse signal to locate a destroyed filter hose. In a delay of the 'Dust too High' signal, already another valve can have been triggered, which then leads to a wrong information. In order to avoid that an unspecific 'Dust too High' message can be sent with 'Permanent' from the master control.</p> <p>perm; digital input dust increase = 1 %</p> <p>perm; digital input dust increase = 2... 100 %</p> <p>perm; analog input dust increase = 2 .. 100 %</p> <p>act.pulse; analog input dust increase = -1 .. -100 % for relative values dust increase = 1 .. 100 % for absolute values</p>
13.10 Dust delay	Blinds out the increased dust output on the outlet side during the cleaning and shortly afterwards.
13.11 Valve current	If two valves are operated at one output, and a valve has an interruption, this will not be recognised by the malfunction monitor of the valve controller. A minimum flow for 2 valves is set here, and in case of a drop this means a fault of a valve. By setting 0.1A this monitor is switched-off.
13.12 Odd valve count	Is important only, if two valves per output are connected. For the power monitor not to report a valve error during an odd number of valves, the slave must be mentioned 0: none Slave1; 2: Slave2; 3: Slave1 and Slave2
13.13 Hold function	No: alarm is reversed when the cause is removed Yes: alarm is held and requires an acknowledgement.
13.14 Fail-Safe	Logic value of alarm messages. No: high for active alarms Yes: low for active alarms Applies also for signal level in data communication
14 Dust monitoring	

Parameter	Description
14.1 Central dust sensor	<p>Function is deactivated / activated with the number of installed central dust sensors. No 1...3, No = deactivated</p> <hr/> <div style="display: flex; align-items: center;">  <p>Note! The controller creates the maximum value via the number of parametrised dust sensors. The monitoring functions affect the determined maximum value.</p> </div> <hr/>
14.2 Dust alarm max.	Global dust monitoring that runs also without valve triggering in the background. If the set value is exceeded the alarm is triggered. If dust delay is set (<i>parameter 14.10</i>) this is applicable here.
14.3 Dust alarm relative	<p>Setting of absolute of relative value No...Yes Yes = absolute No = relative</p>
14.4 Dust pre-alarm	If the set value is exceeded the alarm is triggered.
14.5 Dust main-alarm	If the set value is exceeded the alarm is triggered. If the parameter 14.9 'Lock Dust Valve' is activated, the valves are not triggered any more after activation of the main alarm.
14.6 Dust check time	Time lapse of monitoring window.
14.7 Dust alarm filter	Time lapse in which an alarm is not performed before it is reported.
14.8 Dust sensor dead time	Reaction time of dust sensor. Constant value, which has a delay in time of the dust monitoring as consequence.
14.9 Lock dust valve	<p>Setting valve lock after triggering the main alarm.</p> <p>Yes = Valve will be disabled after main alarm is triggered No = Valve continues to be actuated after main alarm is triggered.</p> <p>Resetting the alarm can remove the locking, however this applies to all valves at the same time.</p> <p>Yes option 1 = Dust valves will be disabled. Enabling takes place independently from the alarm reset via the context key 'Reset Dust Valves' (F1 or F2) in the 'Current Alarms' view (<i>see also chapter 15.1.1 Reset dust valves</i>). The function key is only visible if valves are currently disabled. The dust-contaminated valves are displayed in the alarms list until the function key 'Reset Dust Valves' is pressed.</p> <p>Yes-Opt 2 = as yes-Opt 1 In addition to that the disabled dust valves with the time parameter of background cleaning 'BG Cleaning Time' (<i>see Parameter 6.5</i>) are integrated into the standard cleaning sequence, i.e., one dust-contaminated valve is cleaned every x minutes. The parameter 'BG Cleaning Time' can be adjusted from 0 to 1440 minutes (24 h). The valves are able to "heal" themselves with this slow cleaning action. That means that if the alarm is not triggered again after renewed actuation, the valve functions correctly.</p>
14.10 Dust chart hold	<p>It is set how many seconds after the main alarm is triggered, the recording on the display is stopped.</p> <p>Yes = recording is stopped (1-200). No = recording is not stopped and continues.</p>
14.11 Gas speed max.	Max. gas speed during max. flow rate
14.12 Distance chamber "x"	distance chamber "x" to sensor
15 Cleaning factors	The dust distribution within the entire filter is odd. The first and the last chambers have mostly a higher dust load. The first and the last chambers have mostly a higher dust load. A higher cleaning performance can be assigned to individual chambers (and divisions) by cleaning factors.

Parameter	Description
15.1 Chamber division	The cleaning with chamber division can be weighted differently within a chamber. 0 = switches functioning of cleaning factors off. 1 = chambers are not divided 2 = chambers are divided in 2 parts. RF1 and RF2 are for chamber 1
15.2 Cleaning factor 1	RF1 for chamber 1 division 1
15.3 Cleaning factor 2	RF2, the assignment depends on the selected chamber division.
...	
15.4 Cleaning factor 48	RF48, the last max. possible cleaning factor. Cleaning factors that are not required are ignored. Operating modes of cleaning systems: <u>Permanent cleaning:</u> Time-controlled cleaning <u>Delta-p cleaning:</u> upper threshold starts, lower threshold stops the cleaning process <u>Flow rate controller:</u> Flow rate-dependent differential pressure regulation by pause time variation.
16 Pre-pressure control valve	<i>See chapter 14 Pre-pressure control</i>
16.1 Type of control	0 (Off): no control of cleaning pressure 1 (Delta-p): The control is based on the support curve of the cleaning nominal pressure, which specifies the nominal pressure in relation to the current differential pressure. In addition, the differential pressure can be corrected via the filter resistance. 2 (flow rate): The control is based on the support curve of the cleaning nominal pressure, which specifies the nominal pressure in relation to the current flow rate. 3 (external nominal value): The nominal value is set via the process level interface as process data pool 'PDP external pre-pressure nominal value'. If the process level is not active or the local control is activated, this nominal value is automatically set to the pressure measuring range end value.
16.2 Type of valve	Using the control output for the central isolation valve (HE 5750 digital output DO7). 0 (NC): Isolation valve "normally closed", isolation valve opens as soon as control voltage is applied. 1 (NO): Isolation valve "normally open", isolation valve closes as soon as control voltage is applied. 2 (control valve): when using an external pressure control valve, which is triggered by a standard signal. The pre-pressure control is then not carried out via the central isolation valve.
16.3 Pressure control valve	Max. output pressure for scaling the standard signal. Scaling is done for a 4...20mA output signal (0...16000 µA). For other scaling, the workspace must be converted accordingly.
16.4 Filter resistance 20%	Setting the natural filter resistance for 20% flow rate. To set the resistance, a flow rate signal must be available.
16.5 Filter resistance 80%	Setting the natural filter resistance for 80% flow rate. To set the resistance, a flow rate signal must be available.

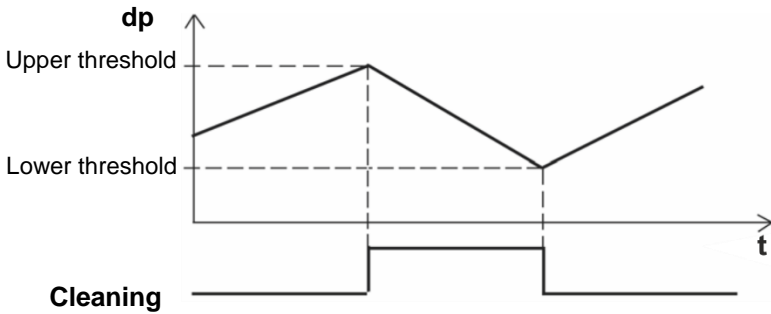
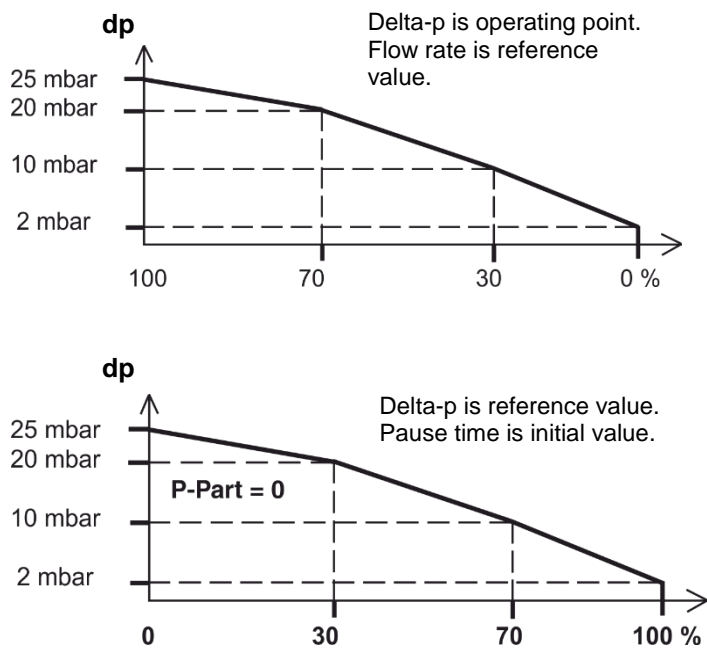
Parameter	Description
16.6 Setpoint 10% ... 16:16 Setpoint 100%	Support curve of cleaning nominal pressures at x% Delta-p or flow rate relating to the set pre-pressure control type. X% relate to the measuring range (Delta-p / Flow rate). Linear interpolation is performed between the setpoints. Setpoints that are not needed are set to the value 0 and thus not used.
17 Delta-p control	
17.1 Lower threshold	<p>A value that is added to the cleaning thresholds. Thus, the filter performance is raised. Also the setpoints of the filter chart are changed.</p>  <p>The graph shows differential pressure (dp) on the y-axis and time (t) on the x-axis. A sawtooth wave represents the filter's pressure over time. Two horizontal dashed lines indicate the 'Upper threshold' and 'Lower threshold'. A solid horizontal line below the lower threshold is labeled 'Cleaning', with a pulse that occurs when the pressure reaches the lower threshold and drops to zero.</p>
17.2 Upper threshold	
17.3 Delta-p offset	
17.4 Setpoint 0%	Recommended: larger than 0 (e.g. 2 mbar)
17.5 Setpoint 10%... 100%	 <p>The top graph shows differential pressure (dp) on the y-axis (25 mbar, 20 mbar, 10 mbar, 2 mbar) and flow rate on the x-axis (100, 70, 30, 0 %). A line connects (100, 25) to (0, 2). A point at (70, 20) is marked with a dashed line to the y-axis. Text: 'Delta-p is operating point. Flow rate is reference value.'</p> <p>The bottom graph shows the same y-axis and a different x-axis (0, 30, 70, 100 %). A line connects (0, 25) to (100, 2). A point at (30, 20) is marked with a dashed line to the y-axis. Text: 'Delta-p is reference value. Pause time is initial value. P-Part = 0'.</p>
18 Controller parameter	Setting the pause time To achieve a continuous cleaning, the pause time between two valve triggerings varies, depending on the current filter status. Influencing variables are either only the differential pressure or additionally also the air flow (depending on the selected settings).
18.1 Maximum Pause	

Parameter	Description
18.2 P-part (proportional band)	<p>A special function is linked to setting P-part = 0!</p> <p>The controller determines the controller deviation against the filter characteristic described by the setpoints.</p> $Y_p = \text{'Maximum Pause'} * dX \text{ (mbar)} * kP \text{ (\%/mbar)}$ <p>Thus, the calculated pause time cannot be longer than the set maximum pause (17.1).</p>
18.3 I-part (reset time)	
18.4 D-part (hold-back time)	
18.5 Dt1-part	
18.6 Proportional Pause	<p>Proportional factor for the pause time prolongation.</p> <p>The proportional factor for the pause time prolongation helps to achieve a better adjustment of the controller to the filter behaviour related to the actual flow rate.</p> <p>In small air flows only a minimum cleaning is required, i.g. the pause prolongation is relatively high. To be able to react appropriately in low differential pressure modifications, the disproportionate considerable modifications of the pause time are required.</p> <p>However, to avoid controller vibrations, the modification of the pause time must take place in small steps only in considerable flow rates. With the default setting of 10%, the P-part during max. flow rate is reduced to 10%.</p>
18.7 Controller modification	<p>Adjustment of the controller in case of chamber isolation.</p> <p>The setpoints of the filter characteristic (14) relate to a filter, which is completely available with all chambers. It is logical that a chamber isolation is combined with a reduction of the available filter area. Thereby the area load of the remaining chambers is increasing respectively, and also the differential pressure above the filter (during same flow rate and dust input).</p> <p>The controller algorithm in the filter control calculates the absolute air flow back to the corresponding air flow per chamber. In order to justify the increased differential pressure during chamber isolation, the Controller Modification is used. Effect: the working point of the remaining filter is set higher by the factor Controller Modification than described by the setpoint of the filter characteristic curve (14).</p>
18.8 Controller maximum	<p>If the differential pressure exceeds the limit value Controller Maximum, the controller is stopped and cleaned with min. pause time (= max. speed).</p>
19 Extras (only via SmartTool)	
19.1 LCD contrast	
19.2 LCD brightness	

10 Commands

10.1 Command sources

Command sources (acc. to priority)

1. SIO Serial interface RS232
2. Connection process control Profibus command or Parallel interface
3. Local operating elements HE 5750 Function keys
4. Local operating elements

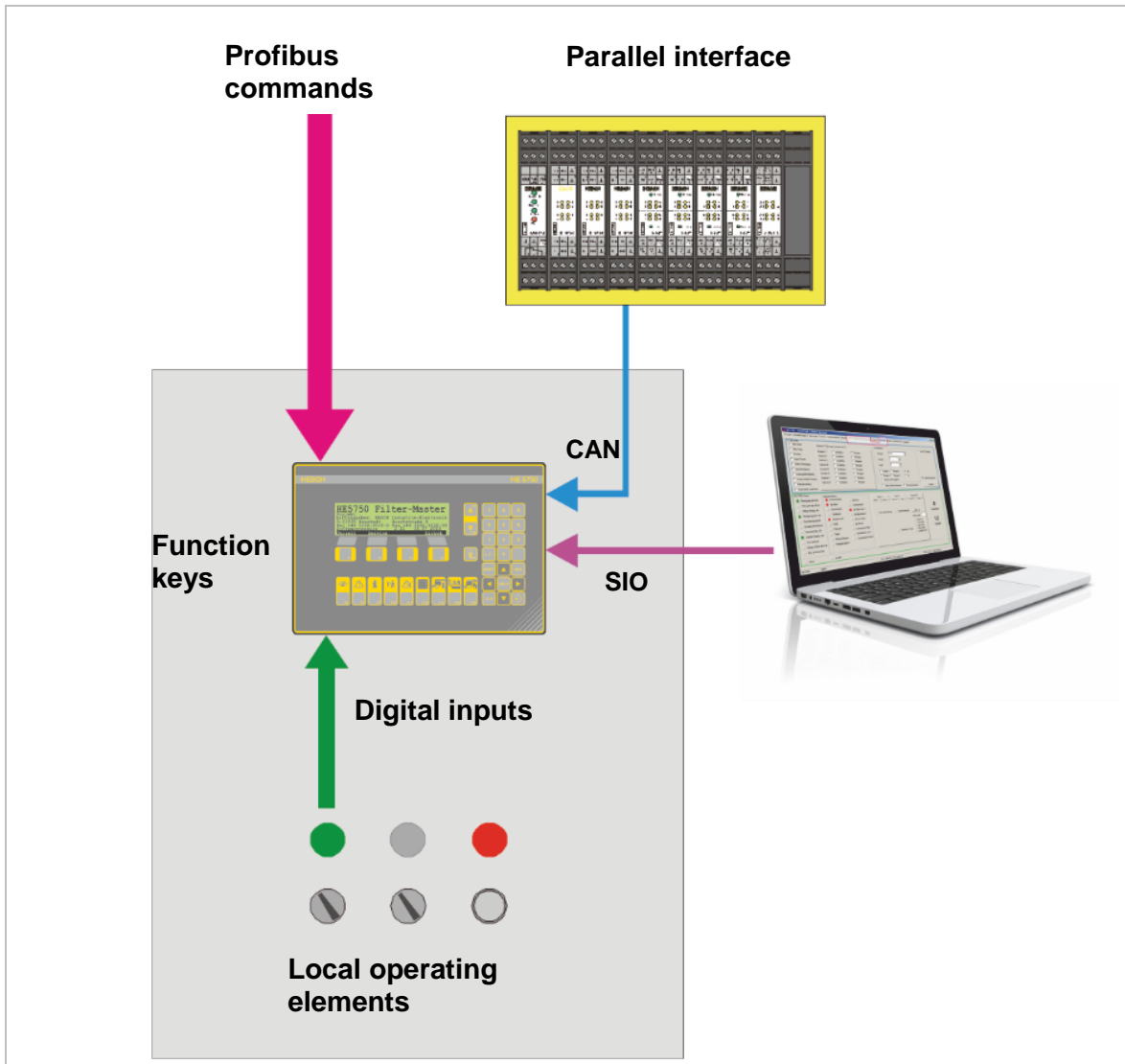

Figure 20. Inputs / commands

Via the serial interface and the Profibus DP interface, all commands can be accessed. Via the parallel interface there is only access to a subset of the entire commands. The signal exchange list of the parallel interface is variable and is defined project-related. The command sources are subject to a priority order. Sources of higher priority overwrite lower priorities. Thus, displays can be activated at the control without accepting control commands via the keyboard!

10.2 Command diagram

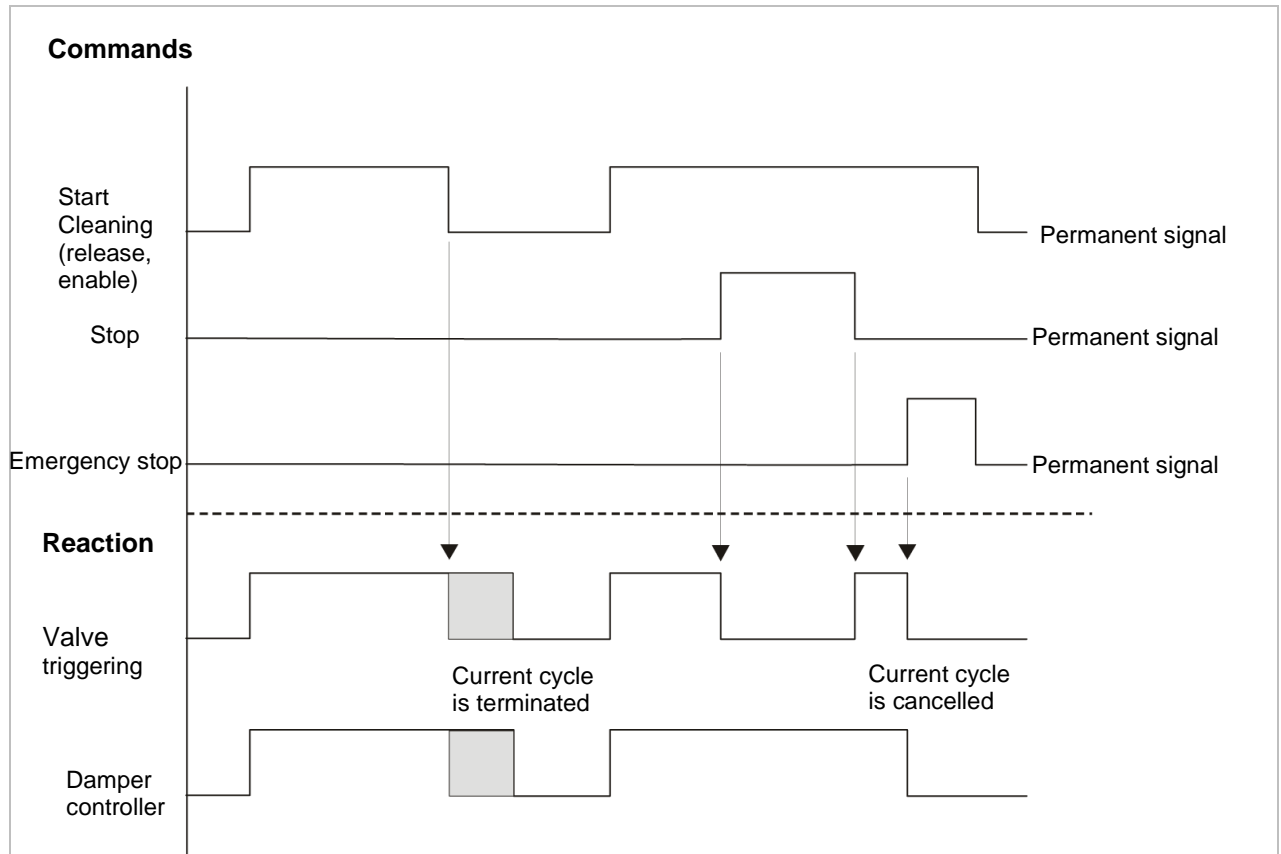

Figure 21. Command diagram

10.3 Local operation / remote control

Extended Local operation

Via additional switches and keys at the front door of the main control cabinet (optional). The extended local operation can be activated via the 'SmartTool' or via the process control.

Remote control

If the Bit 'Remote Operation' is set, the key operation at the controller is annulled. Displays remain active, however modifications are not possible any more. This function can be activated by the process control or via the service interface. After a set time, the status 'Remote Operation' deactivates itself without process control contact. After termination of the time *Autostart/ Timeout* → *Remote timeout* without communication with the process control, the key operation is released again.

The functions 'Local Operation' and 'Remote Operation' are independent from each other. It is possible to lock the local operating elements without deactivating the key operation and vice versa.

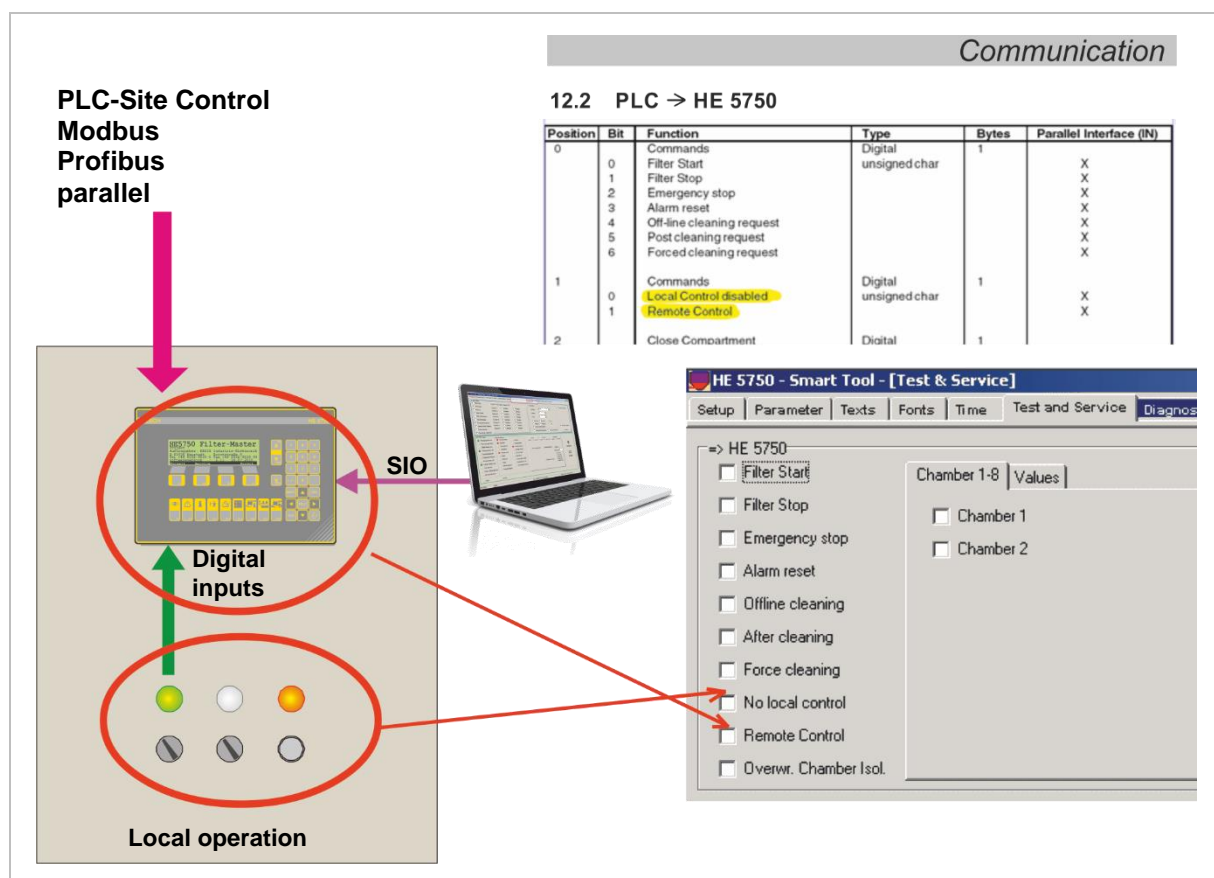

Figure 22. Local operation / remote control

11 Alarm and error messages

11.1 System start

The Master controller tries to establish a valid CAN communication with the node (CAN controller HE 5724 and HE5910 damper control and Extra-I/O) acc. to the system parameters.

```

CAN-Open Management
Sending Parameters .....
1 2 17 18 33 36 41

Checking Slaves      2
    
```

Errors at the start of CAN communication are displayed **inversely**.

Error Message	Criterion	Error cause
Bus error (inverted node number)	Communication with node failed	-CAN wire interrupted or not connected. -HE5724 no voltage. -HE5910 no voltage. -HE5724, HE5910 defect. -fuses triggered. -CAN wire not terminated. -wrong node ID set. -no common baud rate. -system description does not correspond to the actual hardware. <u>When operated with HE 5750 switch unit:</u> -CAN wire interrupted when HE 5750 Master controller is started. -Master controller in Standby.

The errors are listed in the alarm protocol. Access with F6 key.



Note!

Parameters that can possibly be set wrong, are highlighted in *italic* letters in the following table.

Error Message	Criterion	Error cause
Malfunction (Inverse node ID)	Communication with node functions, configuration information of node is evaluated.	-cards in HE5910 node are inserted wrong. -cards are missing or defect. -sensor break or sensor is not connected. -sensors report a short circuit. - system description does not correspond to the actual hardware

11.2 Alarm screens

A warning triangle in the display indicates pending alarms.

<p>Large triangle Current Alarms existing</p>	<p>The screenshot shows a green background with white text. At the top, it says 'Cleaning' and '21.04.2016 Do 12:11:14'. Below that, there are several lines of data: '2 Chamber', '13.1 mbar', '1 Valve', '5.0 bar', and 'Parameter Extra-ID'. A large black warning triangle with a red border is positioned in the bottom right corner of the screen.</p>
<p>Small triangle Alarm protocol with entries</p>	<p>This screenshot is identical to the one above, showing the same data and a large warning triangle. However, the warning triangle in this image is significantly smaller than the one in the previous image.</p>

Current Alarms

(The currently existing alarms)

If a cause for alarm is removed, the message disappears (hold-function for alarms must not be switched on). With the F11 key alarm messages, which are not the latest ones are reset, if the Hold-Function is switched on.

```
Actual alarms                2 : 15
HE5910 33 Bus-Error
HE5910 36 Bus-Error
System pressure low
Ch. 1 Valve control. 2 Bus-Error
Ch. 1 Manifold press. 1 Sensor break
Ch. 2 Valve control 1 Bus-Error
Back
```

Alarm protocol

(A list of all occurred alarms sorted acc. to timely appearance).

Latest alarms are displayed first.
Max. 200 alarms are listed.
With F1 individual alarms are acknowledged.

```
Alarm protocol                Count : 166
01 26.01.2007 10:18:06
Ch. 1 Valve control. 1 Bus-Error
02 26.01.2007 10:17:52
Ch. 1 Dust sensor 2 Sens. shortcut
03 26.01.2007 10:17:52
Ch. 1 Dust sensor 2 Sensor break
Acknowl.   Delete   Reset   Back
```



Toggleing possible between both displays with the F6 key.

11.3 Alarms of current operation

The cleaning process and the connected hardware are monitored regarding errors. Sensoric and actoric are connected at the individual devices. The HE 5910 units shown in Figure 23 are unnecessary components of the controller.

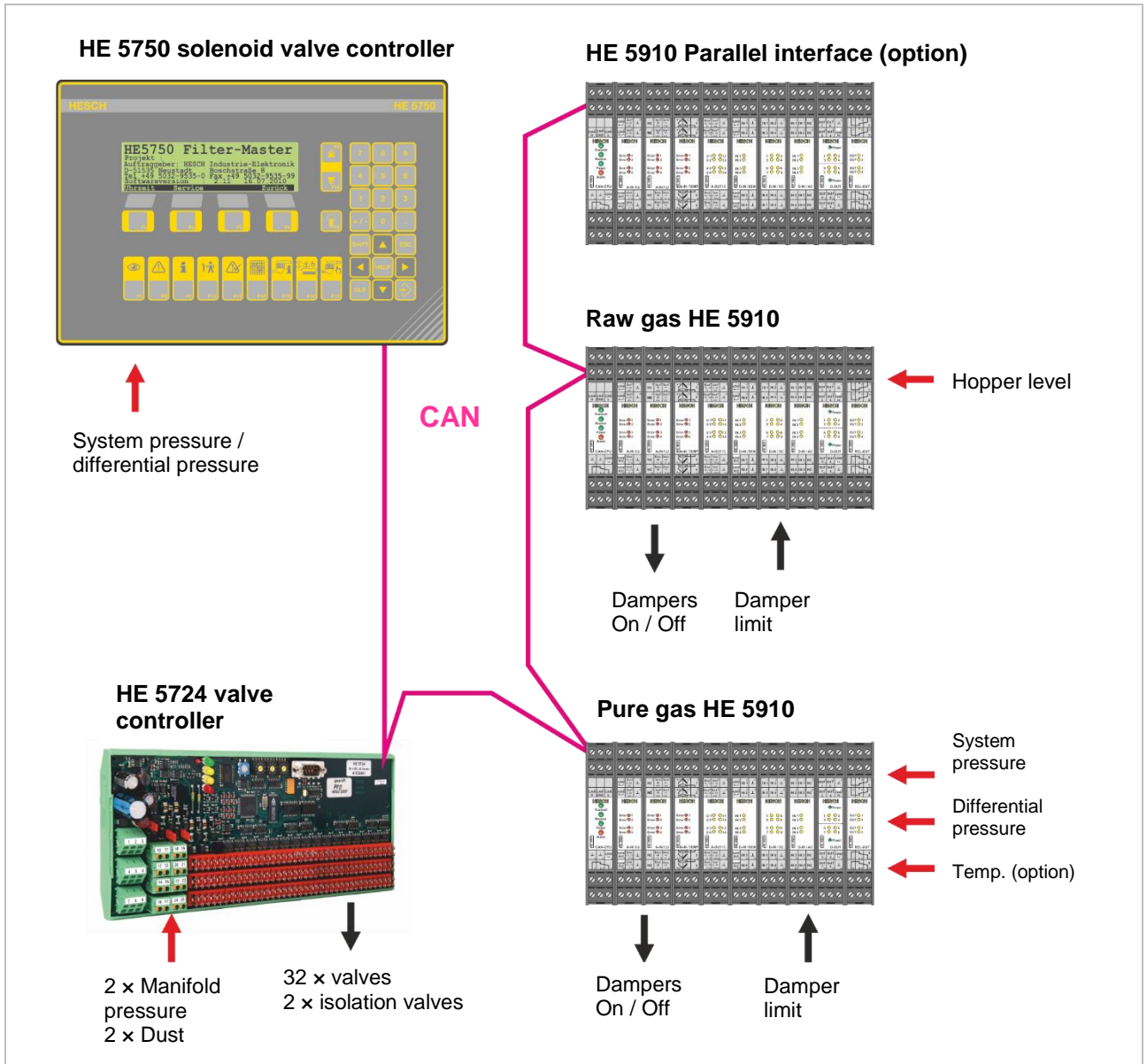

Figure 23. Alarms of current operation

The sensors for system pressure and differential pressure can be connected either at the Master or at the analogue inputs of the HE 5910 Extra-I/O.

11.3.1 Sensor error

Error Message	Criterion	Error cause
Analog-In Sensor break	Analog input at Master open or short circuited.	- sensor error - sensor not connected - system description does not correspond to the actual hardware.
Analog-In Sensor short circuit		

Analogue values may be read with the Masters or with analogue input cards in the damper controllers. Which inputs are used has to be defined with the software 'SmartTool'.

11.3.2 Pressure error



Note!

Parameters that can possibly be set wrong, are highlighted in *italic* letters in the following table.

Error Message	Criterion	Error cause
Delta-p High Alarm 1	Pressure exceeds the defined limit for Alarm 1	- <i>Delta-p High Alarm 1</i> too low - sudden dust rise
Delta-p High Alarm 2	Pressure exceeds the defined limit for Alarm 2	- <i>Delta-p High Alarm 2</i> too low - sudden dust rise
Delta-p Low Alarm	Pressure is below the defined limit	- <i>Delta-p Low Alarm</i> too high - no gas flow
Delta-p Sensor error	Value complies to the highest or lowest limit, HE 5910 unit reports error	- open wire to sensor - short circuit at sensor
System Pressure High Alarm	System pressure exceeds the defined limit	-Compressed air supply defect - <i>Pressure High Alarm</i> to low
System pressure Low Alarm	System pressure to low	-Compressed air supply defect - <i>Minimum pressure</i> set too high
System pressure sensor error	Value complies to the highest or lowest limit, HE 5910 unit reports error	- open wire to sensor - short circuit at sensor

11.3.3 Damper error



Note!

Parameters that can possibly be set wrong, are highlighted in *italic* letters in the following table.

Error Message	Criterion	Error cause
Raw gas damper 1 does not open to pure gas damper 2 does not close	After triggering the damper after a set operation time, the opposite end switch must report the new damper position	<ul style="list-style-type: none">- end switch was not activated- <i>damper control time</i> set too tight- <i>damper limit level</i>, wrong logic level of damper message- damper or end switch defect- wire breakage at damper or end switch- dust deposit affects the functioning of the dampers or end switches

11.3.4 Valve Controller Bus Error

Error Message	Criterion	Error cause
Ch. 2 Slave 1 Bus Error	No communication with this controller	<ul style="list-style-type: none">- wire interruption- no voltage supply at node-fuse triggered

11.3.5 Valve error



Note!

Parameters that can possibly be set wrong, are highlighted in *italic* letters in the following table.

Error Message	Criterion	Error cause
Ch. 3 valve 1 Wire break	Output is monitored: open valve output	- Valve not connected - Valve defect
Ch. 3 valve 2 Overcurrent	Output is monitored: Short circuit at valve output	- Wire crushed - Valve defect
Ch. 3 valve 3 not opening	No short-time pressure drop at the local pressure manifold	- Valve defect - Value <i>pressure drop</i> too high
Ch. 3 valve 4 not opening	No short-time pressure rise at the local pressure manifold	- Valve defect - Value <i>pressure rise</i> too high - Isolation valve does not open
Ch. 3 valve 5 no pressure	Manifold pressure has not regenerated within the manifold refill time	- Valve defect - <i>manifold refill time</i> too low - System pressure too low - Isolation valve does not open - Fuse of isolation valve triggered

11.3.6 Valve controller manifold pressure-sensor error

Error Message	Criterion	Error cause
Ch. 3 Tank Pressure 1 Sensor Malfunction	Input is monitored: open sensor input	- wire interruption - sensor not connected - pressure sensor defect
Ch. 4 Tank Pressure 4 Sensor short circuit	Input is monitored: short-circuited sensor input	- wire crushed - pressure sensor defect

11.3.7 Valve controller isolation valve-error

Error Message	Criterion	Error cause
Ch. 5 Isolation valve 1 wire break	Output is monitored: open output	- wire interruption - valve not connected - isolation valve defect
Ch. 5 Isolation valve 2 overcurrent	Output is monitored: short-circuited output	- wire crushed - isolation valve defect

11.3.8 Valve Controller dust sensor-error

Error Message	Criterion	Error cause
Ch. 6 tank pressure 1 sensor break	Input is monitored: open sensor input	<ul style="list-style-type: none"> - wire interruption - sensor not connected - dust sensor defect
Ch. 6 dust sensor 2 sensor shutter	Input is monitored Short-circuited sensor input	<ul style="list-style-type: none"> - wire crushed - dust sensor defect

11.3.9 Valve controller tank pressure-error (sensor ok)

Error Message	Criterion	Error cause
Ch. 7 tank pressure 1 low (manifold 1-4)	Pressure value lower than set with 'Minimum Pressure' (13.5)	<ul style="list-style-type: none"> - isolation valve does not open - system pressure missing - value set too high

11.3.10 Valve controller valve error dust too high

Error Message	Criterion	Error cause
Ch. 8 valve 15 dust high	Dust rise too high due to valve triggering	<ul style="list-style-type: none"> -dust rise set too low - dust delay too low - filter hose ripped - dust sensor contaminated

11.3.11 Valve controller dust too high

Error Message	Criterion	Error cause
Ch. 6 dust too high	Signal of dust sensor exceeds set limit	<ul style="list-style-type: none"> - sensor contaminated - dust rise set too low

11.3.12 Hopper level

Error Message	Criterion	Error cause
Ch. 1 Hopper level too high	Hopper level sensor reports signal for hopper level reached	<ul style="list-style-type: none"> - sensor defect - wire damaged

11.3.13 Valve controller isolation valve locked

Error Message	Criterion	Error cause
Ch. 7 Isolation valve 1 locked	Valve error 'Valve not Closing' detected	A valve does not close and the manifold is switched off by the isolation valve. The valve can be opened manually with F14 key.

12 Communication

12.1 Master-Slave CAN Communication

Node	Direction	PDO ³	Type	Byte	Bit	Function	Data type	Object	SI
Slave	Txd	1	Digital	1	0	Pressure 1 ok	unsigned char	5300	1
0x180+	Inputs			Status	1	Pressure 2 ok			
					2	Dust 1 ok			
					3	Dust 2 ok			
					4	Valve current ok			
					5	Pressure profile ok			
					6	Dust ok			
					7	Isolation valve 1 triggered (open)			
		1	Digital	2	0	Single valve test active	unsigned char		2
				Status	1	Test cycle active			
					2	End of test			
					3	Test cancelled			
					4	Isolation valve 2 triggered			
		1	Digital	3		Current valve	unsigned char		3
		1	Digital	4		Valve error status	unsigned char		4
					0	Interruption			
					1	Overcurrent			
					2	No pressure drop			
					3	No pressure rise			
					4	No pressure (before triggering)			
					5	Dust rise			
		1	Digital	5		Valve error	unsigned char		5
		1	Digital	6		Isolation valve error status	unsigned char		6
					0	Isolation valve 1 interruption			
					1	Isolation valve 1 overcurrent			
					2	Isolation valve 2 interruption			
					3	Isolation valve 2 overcurrent			
		1	Digital	7		Sensor error state	unsigned char		7
					0	Pressure 1 sensor break			
					1	Pressure 1 sensor shutter			
					2	Pressure 2 sensor break			
					3	Pressure 2 sensor shutter			
					4	Dust 1 sensor break			
					5	Dust 1 sensor shutter			
					6	Dust 2 sensor break			
					7	Dust 2 sensor shutter			
			Analogue	8		Valve current	unsigned char		8
0x280+		2	Analogue	1		Pressure 1	char +/-100%	5400	1
				2		Pressure 2	char +/-100%		2
				3		Dust 1	char +/-100%		3
				4		Dust 2	char +/-100%		4
				5		Pressure 1 Delta	char +/-100%		5
				6		Pressure 2 Delta	char +/-100%		6
				7		Dust 1 Delta	char +/-100%		7
				8		Dust 2 Delta	char +/-100%		8
0x200+	Rxd	1	Digital	1	0	Valve triggering	unsigned char	5500	1
	Outputs			Action	1	Valve monitoring			
					2	Isolation valve 1 open			
					3	Local test deactivated			
					4	Current monitoring			
					5	Scan			
					6	Error acknowledgement			
					7	2. Control time			
		1	Digital	2		Current valve	unsigned char		2
		1	Digital	3	0	Isolation valve 2 open	unsigned char		3

³ Process data object

12.2 Data direction PLC -> HE 5750

Position	Bit	Function	Data type	Bytes	Parallel Interface (IN)Bit
0		Commands	Digital	1	
	0	Filter start	unsigned char		X
	1	Filter stop			X
	2	Quick Hold (emergency stop)			X
	3	Alarm reset			X
	4	Requirement Offline cleaning			X
	5	Requirement post-cleaning			X
	6	Requirement forced cleaning			X
	7	Parallel valve triggering locked			
1		Commands	Digital	1	
	0	Local operation locked	unsigned char		X
	1	Remote control			X
	2	Cancel local 'Chamber close'			
	3	Delta-p offset activated			
	4	Time synchronised			
	5	Dust monitoring locked			
	6	Deactivating modem interface			
	7	Toggle Bit			
2		Close chamber	Digital	1	
	0	Chamber 1	unsigned char		X
		to			X
	7	Chamber 8			X
3		Close chamber	Digital	1	
	0	Chamber 9 to	unsigned char		
	7	Chamber 16			
4		Close chamber	Digital	1	
	0	Chamber 17 to	unsigned char		
	7	Chamber 24			
5		Chamber cleaning	Digital	1	
	0	Chamber 1 to	unsigned char		
	7	Chamber 8			
6		Chamber cleaning	Digital	1	
	0	Chamber 9 to	unsigned char		
	7	Chamber 16			
7		Chamber cleaning	Digital	1	
	0	Chamber 17	unsigned char		
		to			
	7	Chamber 24			
8		Delta-p offset 'lower threshold'	signed int	2	
10		Delta-p offset 'upper threshold'	signed int	2	
12		Extra Pause 1st cycletime	unsigned int	2	
14		Extra Pause 2nd cycletime	unsigned int	2	
16		reserved		4	
		Test functions			
20		Test command	Digital	1	
		1 = valve test	unsigned char		
		2 = Chamber cleaning			
		3 = damper controller			
		4 = isolation valves			
21		Chamber number	unsigned char	1	
22		Valve number	unsigned char	1	
23		Damper selection	Digital	1	
	0	Raw gas damper 1	unsigned char		
	1	Raw gas damper 2			
	2	Pure gas damper 1			

Position	Bit	Function	Data type	Bytes	Parallel Interface (IN)Bit
	3	Pure gas damper 2			
	4	Damper control direction 0 = open 1 = close			
	5	Isolation valve opening			
24		Commands 3	unsigned char	1	
	0	Standby request (Redundancy mode)	(rising edge)		
25		reserved		6	

12.3 Data direction HE 5750 -> PLC

Position	Bit	Function	Data type	Bytes	Parallel Interface (Out)
0		Status information part 1	Digital	1	
	0	Cleaning activated	unsigned char	X	X
	1	Filter Hold (emergency stop)		X	X
	2	Offline cleaning activated			X
	3	Cleaning running		X	X
	4	Post-cleaning running			
	5	Forced cleaning running			
	6	Chamber cleaning running			
1	7	Local operation unlocked			
		Status information part 2	Digital	1	
	0	Test function activated	unsigned char		
	1	Delta-p offset activated			
	2	Time synchronised			
	3	Background cleaning in process			
	4	Dust monitoring locked			
	5	Modem interface deactivated			
2	6	Parallel valve triggering locked			
	7	Toggle Bit			
		Current chamber	unsigned char	1	
	3	Current valve	unsigned char	1	
	4	Chamber closed	Digital	1	
	0	Chamber 1 to	unsigned char		
	7	Chamber 8			
	5	Chamber closed	Digital	1	
0	Chamber 9 to	unsigned char			
	7	Chamber 16			
6	Chamber closed	Digital	1		
	0	Chamber 17 to	unsigned char		
7	Chamber 24				
7	Chamber cleaning active	Digital	1		
	0	Chamber 1 to	unsigned char		
7	Chamber 8				
8	Chamber cleaning active	Digital	1		
	0	Chamber 9 to	unsigned char		
7	Chamber 16				
9	Chamber cleaning active	Digital	1		
	0	Chamber 17 to	unsigned char		
7	Chamber 24				
10		Alarms part 1	Digital	1	
	0	Common alarm	unsigned char		X
	1	Differential pressure alarm			X
	2	Error cleaning system pressure			X
	3	Error pressure in chamber pres. manifold			X
	4	Error Isolation valve			X
	5	Valve error			X
	6	Hopper level high			X
7	Exceed threshold dust			X	
11		Alarms part 2	Digital	1	
	0	Error raw gas damper	unsigned char		X
	1	Error pure gas damper			X
	2	Error CAN bus			
	3	Flow rate sensor error			X
4	Wrong command from PLC				

Position	Bit	Function	Data type	Bytes	Parallel Interface (Out)
12		Pressure alarms	Digital	1	
	0	Differential pressure exceeded threshold 1	unsigned char		
	1	Differential pressure exceeded threshold 2			
	2	Differential pressure underrun			
	3	Differential pressure sensor error			
	4	System pressure exceeded			
	5	System pressure underrun			
13	6	System pressure sensor error			
		Status 3	unsigned char	1	
	0	Redundancy mode	1=activated		
	1	Standby (Redundancy mode)	0=active		
	2	Recovering from Standby			
14		reserved	unsigned char	1	
		Chamber related information			
		Chamber 1			
20		Damper status	Digital	1	
	0	Raw gas damper 1 open	unsigned char		
	1	Raw gas damper 1 closed			
	2	Raw gas damper 2 open			
	3	Raw gas damper 2 closed			
	4	Pure gas damper 1 open			
	5	Pure gas damper 1 closed			
	6	Pure gas damper 2 open			
	7	Pure gas damper 2 closed			
21		Pressure information	Digital	1	
	0	Isolation valve 1 Alarm	unsigned char		
	1	Isolation valve 2 Alarm			
	2	Isolation valve 3 Alarm			
	3	Isolation valve 4 Alarm			
	4	Manifold 1 Alarm			
	5	Manifold 2 Alarm			
	6	Manifold 3 Alarm			
	7	manifold 4 Alarm			
22		Valve error	Digital	1	
	0	Wire break	unsigned char		
	1	Overcurrent			
	2	No blowing pressure			
	3	valve not opening			
	4	valve not closing			
	5	Dust pre-alarm			
	6	Dust main-alarm			
23		Number of faulty valve	unsigned char	1	
24		Chamber 2		4	
		Data structure as chamber 1			
to 112		Chamber 24		4	
		Data structure as chamber 1			
Offset		Additional information			
		Offset = 20 +4 x number of chambers			
Offset+0 to Offset+18		Can be configured freely via Smart-Tool			

12.4 Diagnosis HE 5750 at PLC

Position	Bit	Function	Data type	Bytes
0		System status used by Profibus SPC3 chip	unsigned char	6
		EXT_USER_DIAG		
6		1. Header	Digital	1
	7/6	00 = device specific diagnosis		
	5-0	Length = 11 Byte		
7		Status	Digital	1
	0	invalid parameter data	unsigned char	
	1	Invalid configuration		
	2	Invalid command		
	3	Invalid test		
8		I/O-extension status (HE 5910)	Digital	1
	0	I/O-Unit 1 not connected	unsigned char	
	1	I/O-Unit 1 error		
	2	I/O-Unit 2 not connected		
	3	I/O-Unit 2 error		
	4	I/O-Unit 3 not connected		
	5	I/O-Unit 3 error		
	6	I/O-Unit 4 not connected		
	7	I/O-Unit 4 error		
9		I/O-extension status (HE 5910)	Digital	1
	0	I/O-Unit 5 not connected	unsigned char	
	1	I/O-Unit 5 error		
	2	I/O-Unit 6 not connected		
	3	I/O-Unit 6 error		
	4	I/O-Unit 7 not connected		
	5	I/O-Unit 7 error		
	6	I/O-Unit 8 not connected		
	7	I/O-Unit 8 error		
10		I/O-extension status (HE 5910)	Digital	1
	0	I/O-Unit 9 not connected	unsigned char	
	1	I/O-Unit 9 error		
	2	I/O-Unit 10 not connected		
	3	I/O-Unit 10 error		
11		I/O-extension status (HE 5910)	Digital	1
12		reserved		5
		Chamber related		
17		2. Header	Digital	1
	7/6	00 = device specific diagnosis		
	5-0	Length = 33 Byte		
		Chamber 1		
2nd Header+1		Slave Status	Digital	1
	0	Slave 1 not connected	unsigned char	
	1	Slave 1 Error		
	2	Slave 2 not connected		
	3	Slave 2 Error		
2nd Header+2		Pressure alarms	Digital	1
	0	Manifold sensor 1 wire break	unsigned char	

Position	Bit	Function	Data type	Bytes
	1	Manifold sensor 1 short circuit		
	2	Manifold sensor 2 wire break		
	3	Manifold sensor 2 short circuit		
	4	Manifold sensor 3 wire break		
	5	Manifold sensor 3 short circuit		
	6	Manifold sensor 4 wire break		
	7	Manifold sensor 4 short circuit		
2nd Header+3		Isolation valve / dust alarms	Digital	1
	0	Isolation valve Slave 1 wire break	unsigned char	
	1	Isolation valve Slave 1 short circuit		
	2	Isolation valve Slave 2 wire break		
	3	Isolation valve Slave 2 short circuit		
	4	Dust sensor 1 wire break		
	5	Dust sensor 1 short circuit		
	6	Dust sensor 2 wire break		
	7	Dust sensor 2 short circuit		
2nd Header+4		Damper error (exceeds of time)	Digital	1
	0	Raw gas damper 1 not opening	unsigned char	
	1	Raw gas damper 1 not closing		
	2	Raw gas damper 2 not opening		
	3	Raw gas damper 2 not closing		
	4	Pure gas damper 1 not opening		
	5	Pure gas damper 1 not closing		
	6	Pure gas damper 2 not opening		
	7	Pure gas damper 2 not closing		
2nd Header+5		Chamber 2 Data structure as chamber 1		4
to 2nd Header+29		Chamber 8 Data structure as chamber 1		4
50		3. Header	Digital	1
	7/6	00 = device specific diagnosis		
	5-0	Length = 33 Byte		
3rd Header+1		Chamber 9 Data structure as chamber 1		4
to 3rd Header+29		Chamber 16 Data structure as chamber 1		4
83		4. Header	Digital	1
	7/6	00 = device specific diagnosis		
	5-0	Length = 33 Byte		
4th Header+1		Chamber 17 Data structure as chamber 1		4
to 4th Header+29		Chamber 24 Data structure as chamber 1		4
		Additional information Offset = 3 +4 x number of chambers		
116		5. Header	Digital	1
	7/6	00 = device specific diagnosis		
	5-0	Length = 33 Byte		
5th Header+1		4 channel analogue input HE 5750		1
	0	HE 5750 1. Analogue input wire break		
	1	HE 5750 1. Analogue input short circuit		
	2	HE5750 2. Analogue input wire break		

Position	Bit	Function	Data type	Bytes
	3	HE 5750 2. Analogue input short circuit		
	4	HE 5750 3. Analogue input wire break		
	5	HE 5750 3. Analogue input short circuit		
	6	HE 5750 4. Analogue input wire break		
	7	HE 5750 4. Analogue input short circuit		
5th Header+2		4 channel analogue input HE 5910		1
	0	Differential pressure wire break		
	1	Differential pressure short circuit		
	2	Raw gas temperature 1 wire break		
	3	Raw gas temperature 1 short circuit		
	4	Raw gas temperature 2 wire break		
	5	Raw gas temperature 2 short circuit		
	6	Raw gas temperature 3 wire break		
	7	Raw gas temperature 3 short circuit		

13 Solenoid valve controller

13.1 Description

The valve control HE 5724 is part of a field bus valve control system. The controller is delivered completely wired, configured and tested. Further settings or configurations are not required. CAN wire and power supply must be connected.

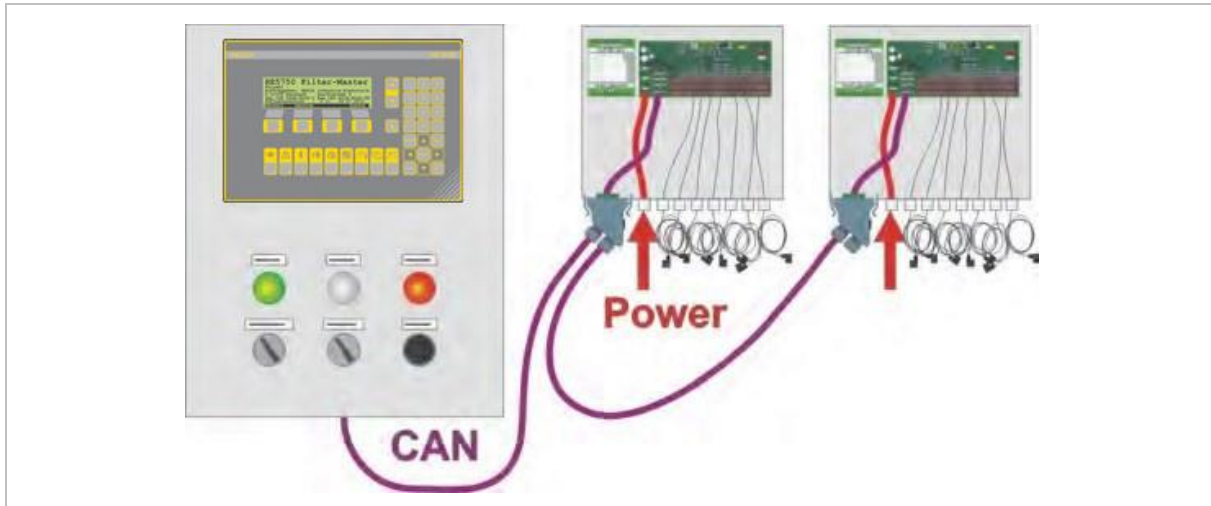

Figure 24. Connection CAN and power supply

13.2 Supply HE 5724



Attention!

The applied voltage must correspond to the voltage indicated on the name plate.

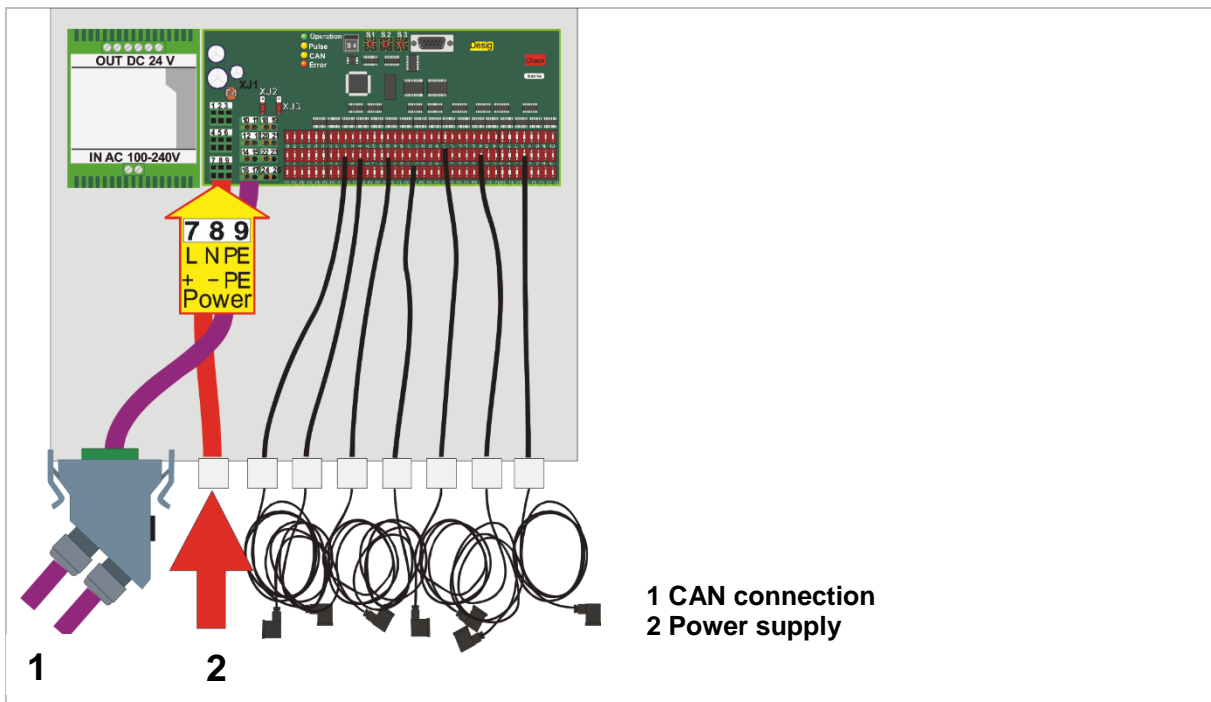







Figure 25. Supply HE 5724

13.3 Status diagnosis HE 5724

LED	Colour	Message
Operation		Lights up permanently, if no EEPROM error exists.
Pulses		Lights up during the pulse output on the cleaning valves.
CAN		Blinks during CAN bus error.
CAN		Lights up permanently, when the connection with the Master is established (CAN status "Operational").
Error		Lights up during following errors: EEPROM, sensor, isolating valve, valve and CAN bus errors

13.4 Terminals and jumpers

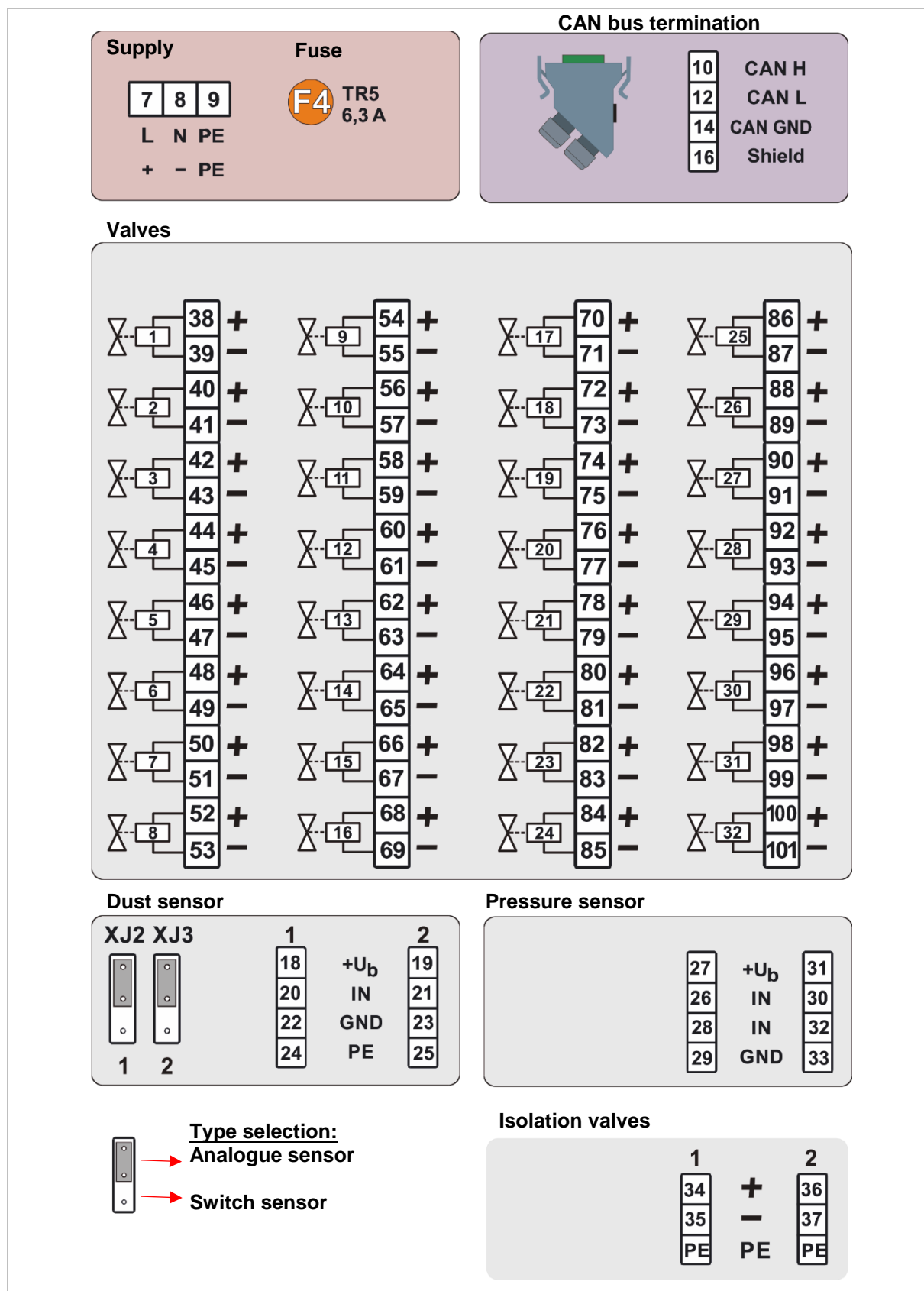

Figure 26. Terminals and jumpers

13.5 CAN wiring and bus termination

The first and the last bus participant must be terminated.
 The wire must be closed with a 120 Ohm resistance at both ends. The Master controller can also be placed in the middle of the network. In that case, the termination resistor of the Master controller must **not** be switched on.

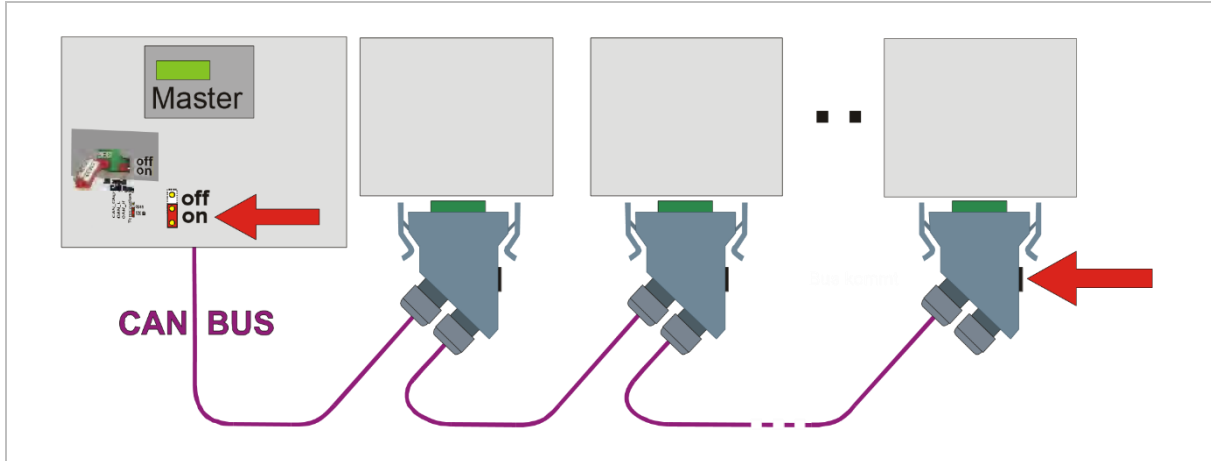

Figure 27. CAN wiring and bus termination

CAN bus connectors:

Signal	Wire	Terminal	Name
CAN-H	white	white	CAN-H
CAN-L	brown	blue	CAN-L
CAN-GND	green	black	
V-shield			

Termination:

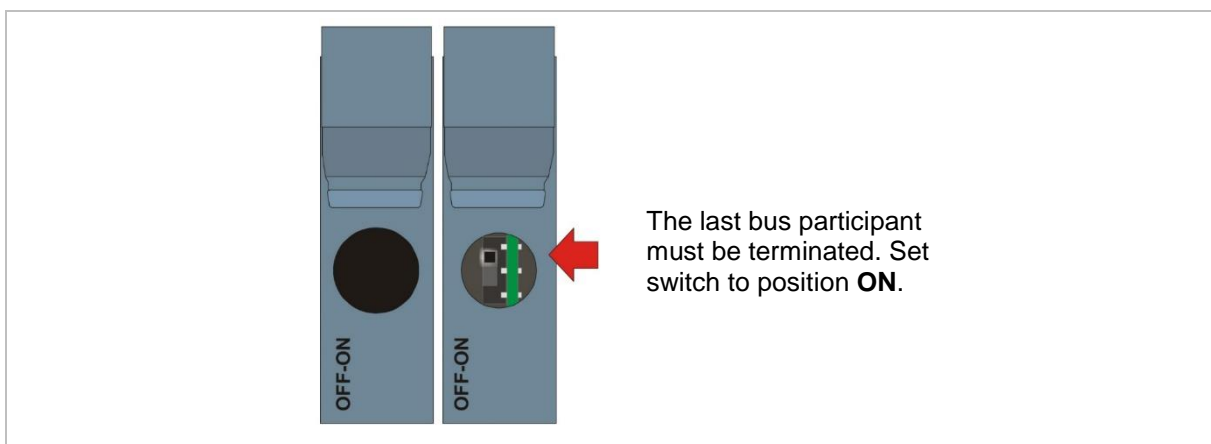

Figure 28. Bus termination

14 Pre-pressure control



Note!

This function is integrated since **software version 2.17**.

The pre-pressure control regulates the cleaning pressure. This can either happen via

- the central isolation valve
- or via an external pressure control valve.

If the central isolation valve is used, the cleaning pressure can only be “refilled”.

The cleaning pressure cannot actively be released, but it reduces indirectly by the pulsing of the cleaning valves. The advantage of this type of pressure equalisation is that a drop in the cleaning nominal pressure has no immediate effect on the entire system.

During a cleaning cycle, a decreasing or increasing cleaning nominal pressure is immediately compensated. If no cleaning cycle is active, there is no compensation of the cleaning nominal pressure.

The following parameters are necessary for the pre-pressure control with central isolation valve:

‘System pressure On’ (4.12)

- activates the central isolation valve and
- indicates the lead time or the time until the cleaning nominal pressure is reached again after the cleaning cycle has been activated.

‘System pressure Off’ (4.13)

- indicates the rest time for the cleaning valve before it is activated again.

If an external pressure control valve is used instead of a central isolation valve, the pre-pressure control is done by scaling the cleaning nominal pressure.

In the process data pool (PDP), the following function codes are available:



- IN: external pre-pressure nominal value
- OUT: pre-pressure nominal value
- OUT: pre-pressure nominal value scaled for external pressure control valve.

These codes can be transferred to the process level via 'SmartTool'.

15 Options

15.1 Central dust monitoring

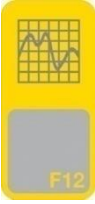
The central dust monitoring is available as an option. Up to 3 central dust sensors, which monitor the dust level of all chambers, are located in the pure gas duct. The controller creates the maximum value via the number of parametrised central dust sensors.

	F12 key: activation of the menu and switching between two trend graphs:
	<ul style="list-style-type: none">• Delta-p graph via different time windows• Dust process graph via different time windows
	<hr/>  Note! From software version 2.13 , the graphic for the filter cycle times is displayed alternately. <hr/>

The filter is described in HE 5750 with additional parameters, in order to give the controller

- the distance between chamber and sensor as well as
- the flue gas speed

The following parameters are necessary:

- ✓ distance chamber 'x' to sensor in [m]
- ✓ max. gas speed [m/s] during max. flow rate
- ✓ Monitoring window length [s]

Additionally the flow rate signal must be added to the control.



Note!

Dust monitoring is deactivated, if flow rate is < 10 %.

The controller calculates the current gas speed by the current air flow Gas speed. This can be used to calculate the time it takes for a dust emission cloud from chamber 'x' to reach the sensor. After this time, the monitoring window length starts. If a 'Dust High' occurs, it is due to valve assigned to this monitoring window, and a respective malfunction message is generated. The controller monitors that monitoring windows do not overlap. In case of doubt, the pause is modified so that a sufficient gap between two windows remains.



Note!

The parameter table for dust monitoring can be found in chapter 9.6 *Parameter table (parameter groups 13-19)*.

The controller offer two trend graphs:

- Dust process via different time windows
- Delta-p graph via different time windows

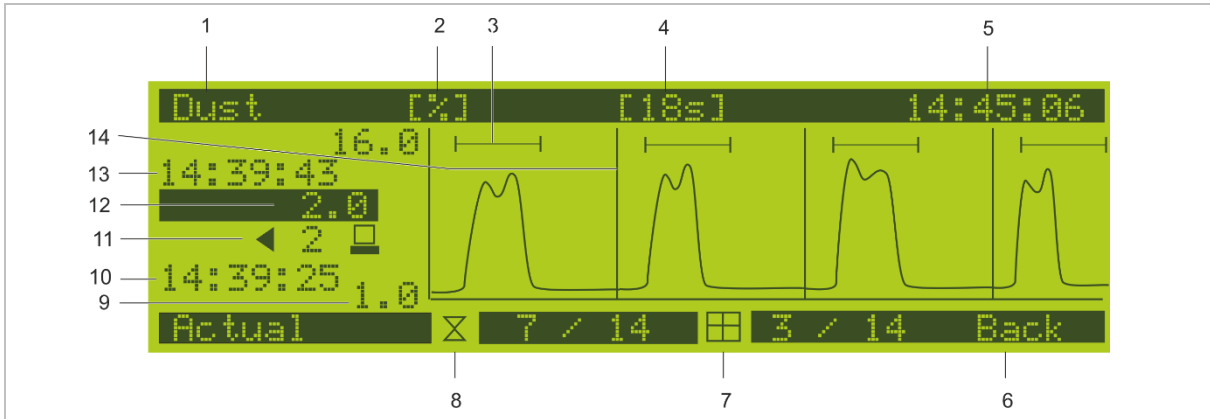

Figure 29. Dust process

The y-axis of the monitoring graph is dynamically scaled.

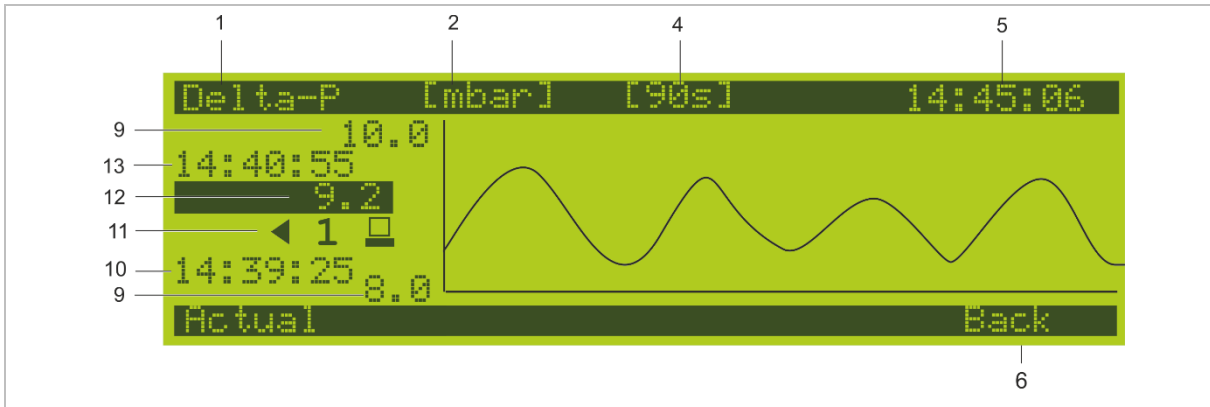

Figure 30. Delta-p graph

- 1 Display of dust process (switching via F12 key)
 - 2 Measuring unit
 - 3 Graphical display of monitoring time
 - 4 Time lapse of display
 - 5 Current time
 - 6 Returning to the main menu via F4 key
 - 7 Chamber / valve of the right time window of monitoring
 - 8 Right triggered valve
 - 9 Diagram scaling (%/mbar)
 - 10 Display time start
 - 11 Number of the displayed time window
 - 12 Current dust or Delta-p value
 - 13 Display time end
 - 14 Symbol (I) for the time of valve triggering
- ◀▶ Time window selectable via arrow keys (to the left = earlier time)
- ▲▼ Displayed time lapse can be reduced / increased via the arrow keys:
 Dust graph: 18 s, 90 s, 6 min., 30 min., Delta-p: 90 s, 6 min., 30 min., 2 h
- F1 The recording is stopped in the display, but keeps on running in the background
- F12 Switching between dust and Delta-p display



Note!

The graphics are created by volatile data, which is stored in the memory during process time. Voltage failure leads to loss of the history.

15.1.1 Reset dust valves

If the dust valves are disabled (see 14.9 Lock Dust Valve), they can be enabled again by pressing the function keys F1 or F2 in the 'Current Alarms' view.

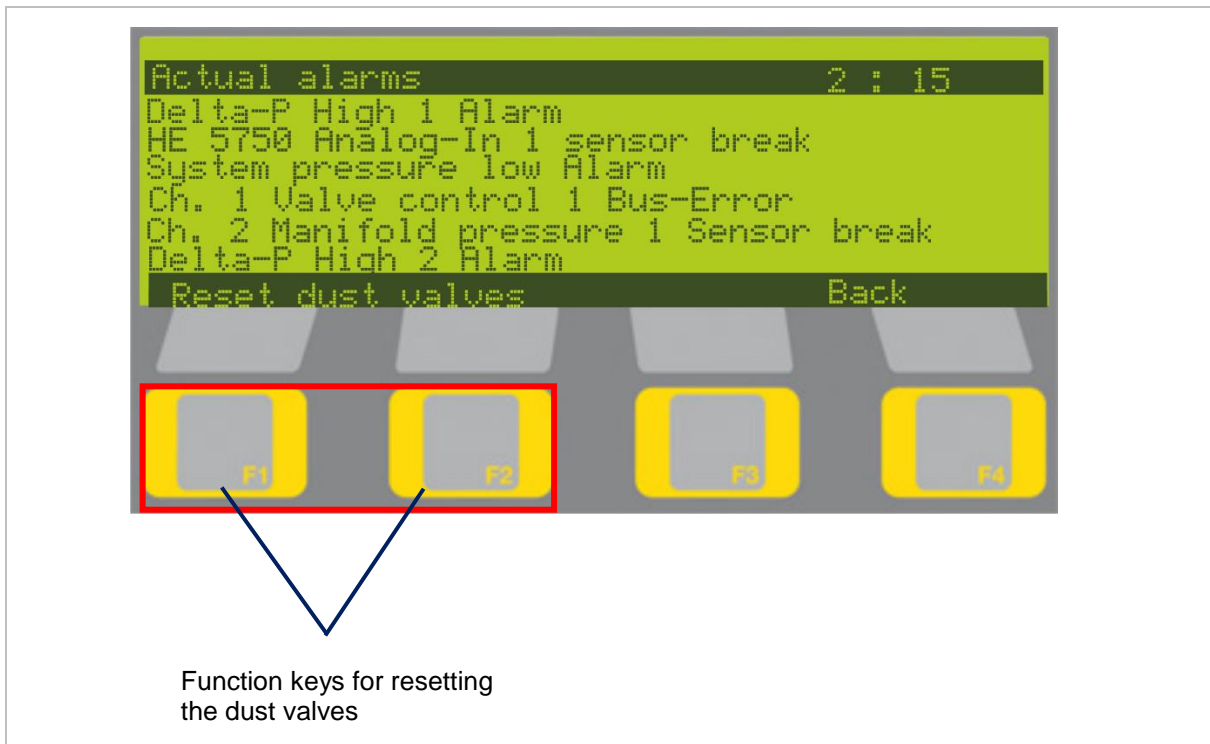

Figure 31. Reset dust valves via context keys F1 and F2

15.2 HE 5750 switch unit

The HE 5750 switch unit is optionally available.

In a HE 5750 filter controller system with two HE 5750 master controllers, the switch unit switches the CAN Slave periphery to one of the two master controllers each.

15.2.1 Safety Information



Danger of Electrocutation!

Before working on the device, switch off all power supplies used. The electrical cables must be laid according to the respective national regulations (in Germany VDE 0100). The measuring cables must be laid separately from the power lines. Connect the protective earth connector (in the respective equipment carrier) to the protective earth conductor.



Danger of Electrocutation!

Any interruption of the protective earth in the equipment carrier can result in the device becoming a hazard. Intentional interruptions are not permitted. If there is a suspicion that it is no longer possible to operate the device safely, it must be shut off and secured against being unintentionally switched on.



Danger of Electrocutation!

Do not open the device when it is connected to the voltage! When opening the devices or removing covers and parts, live parts may be exposed. Connection points can also be live!



Attention!

The device must never be put into operation even if damage is recognisable.



Attention!

During installation, commissioning, maintenance and troubleshooting, observe the accident prevention regulations applicable to your system, e.g. DGUV Regulation 3 "Electrical installations and equipment".



Warning of material damage caused by electrostatic charge!

The device must be cleaned regularly to prevent increased dust generation on the device.
Cleaning of the housing only permitted with **moist** cleaning materials to avoid static charging!



Troubleshooting!

At the beginning of troubleshooting, all possible sources of faults on additional devices or supply lines (measuring lines, wiring, downstream devices) should be taken into consideration. If the fault is not found after checking these points, we recommend sending the device to the supplier.



Decommissioning!

Switch off the power supply on all poles if the device is to be decommissioned. Secure the device against being unintentionally switched on!

If the device is linked to other devices and/or equipment, consider the impacts and take appropriate precautions before switching it off.

15.2.2 Device description of switch unit



Note!

For using the switch unit, **software version 2.16 or higher** must be installed on the connected HE 5750 Master controllers.

The following figure shows the switch unit with name plate and slide-in strips (top and bottom) to designate the connections.

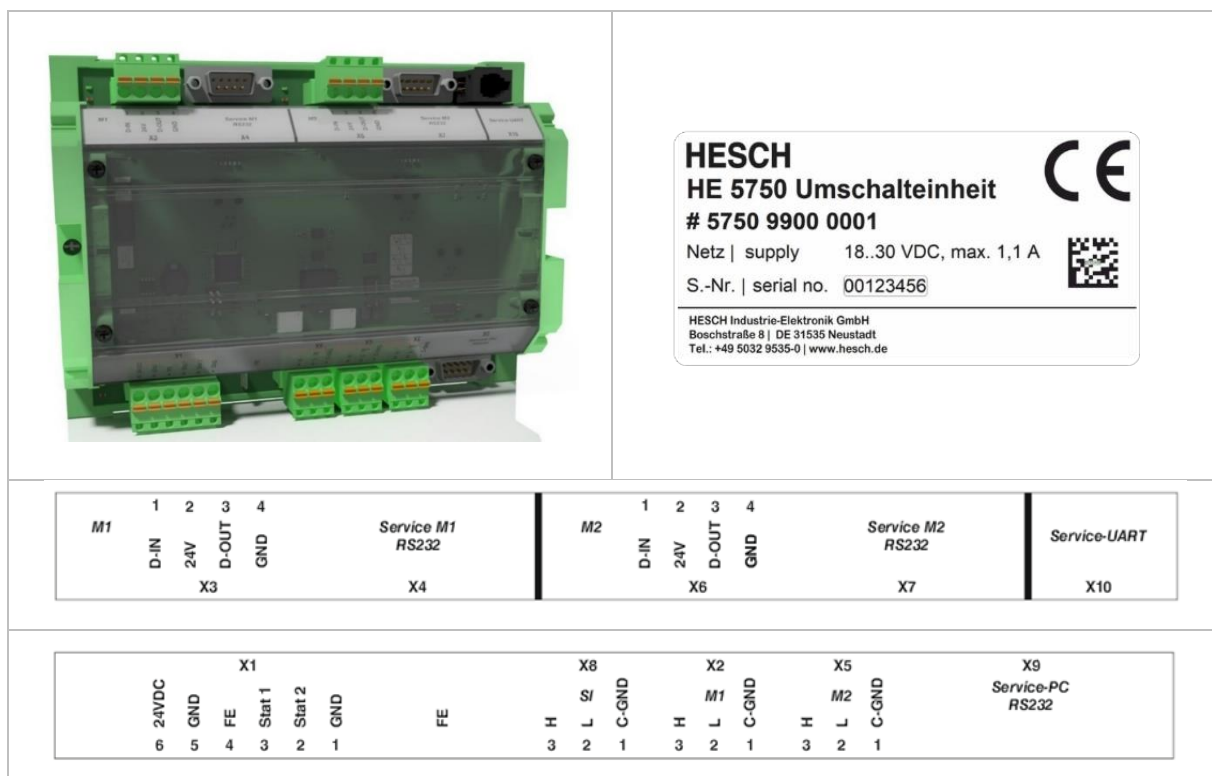

Figure 32. Switch unit with name plate and connection designation

In a HE 5750 filter controller system with two HE 5750 Master controllers, the HE 5750 switch unit switches the CAN Slave periphery to one of the two Master controllers. It controls the CAN-Bus communication between the HE 5750 Master controller and the corresponding Slaves. If the communication between Master and Slave is interrupted, the CAN Bus is switched to the second HE 5750 in Standby mode. This HE 5750 functions as the Master now.

The switch unit also copies the process image and the current parameters of the active HE 5750 Master to the HE 5750 Master in Standby mode. This procedure also serves to monitor the connected HE 5750 master controllers for function or presence of the Master controller.



Note!

A firmware update of a HE 5750 Master controller cannot be done via the switch unit. This must be carried out directly on the HE 5750 Master controller.



Note!

During the switching process, 'SmartTool' data such as texts, drawing sets and Extra I/O are not automatically copied to the new HE 5750 Master controller.

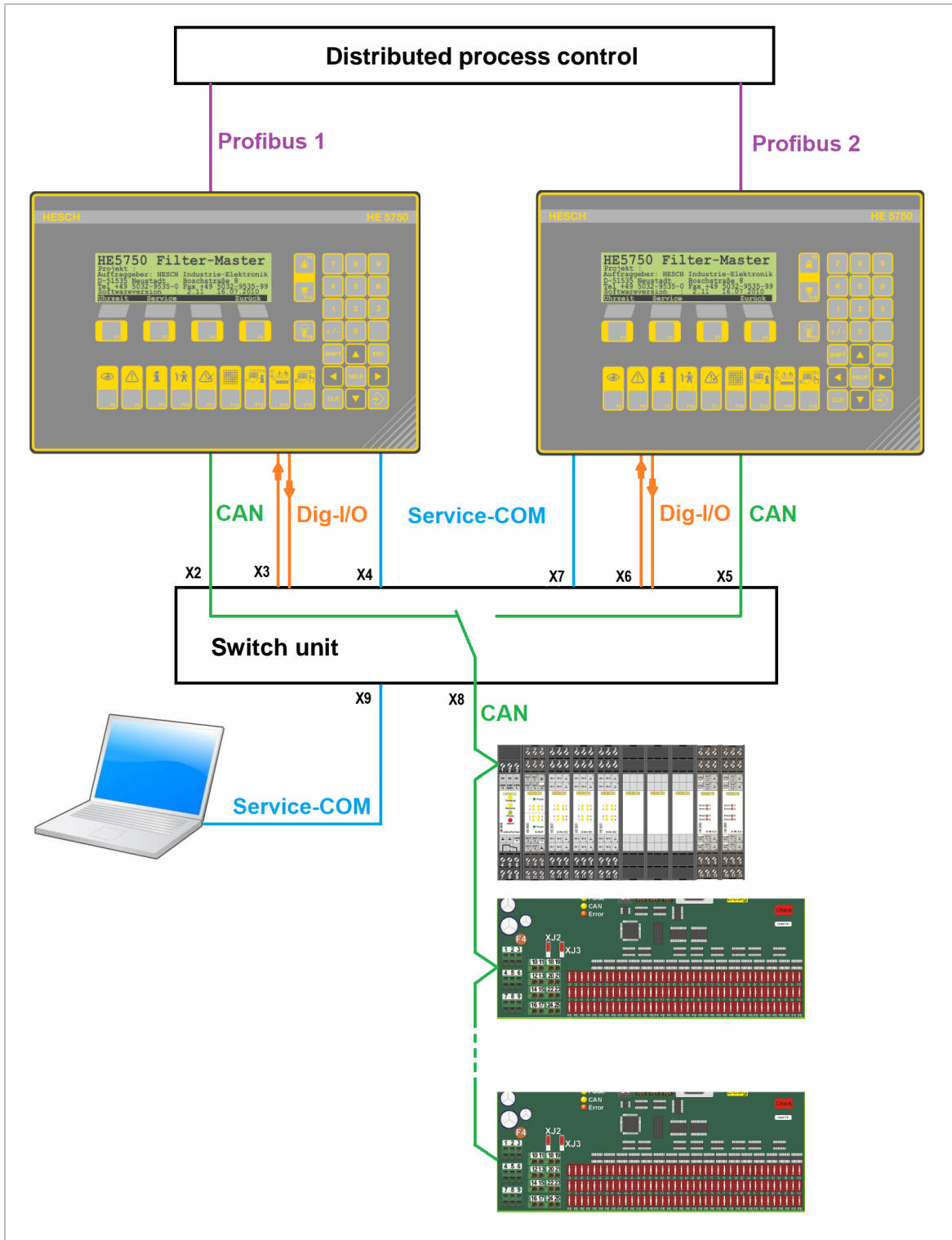
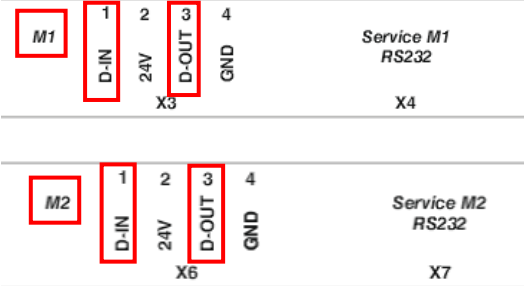
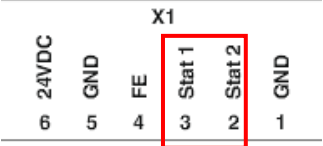
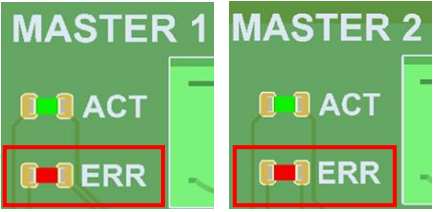
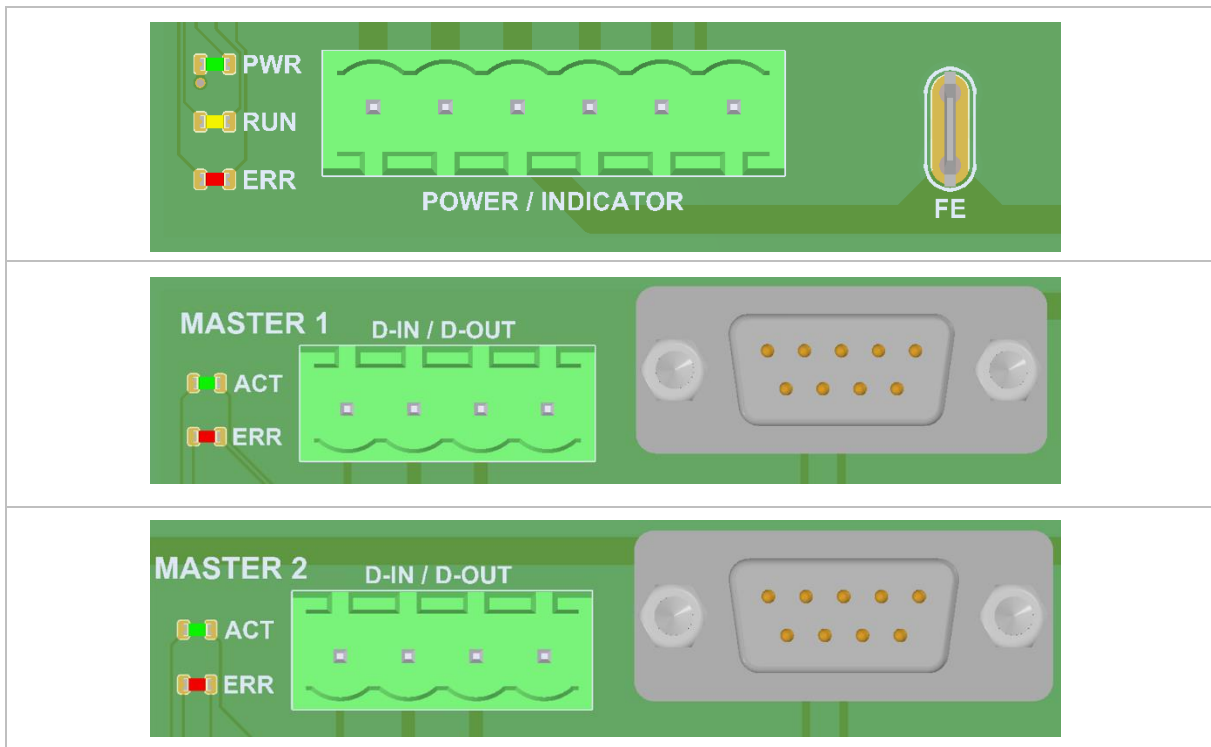







Figure 33. Function sketch of switch unit

The communication between the switch unit and the HE 5750 Master controller necessary for the switching process, is done via a digital input and output per HE 5750 Master controller.

<p>D-Out Switch unit => D-In HE 5750 (M1/M2)</p> 	<p>0=Active, 1=Standby</p>
<p>D-Out HE 5750 => D-In Switch unit</p>	<p>A rising edge (0=>1) of the active HE 5750 Master controller prompts the switch unit to switch to the second HE 5750 Master controller. Provided that this Master controller was “detected” by the switch unit.</p>
<p>D-Out (24 VDC) for signalling (luminous indicator)</p>  	<p>Stat 1 lights up permanently, if the HE 5750 Master controller 1 is activated.</p> <p>Stat 1 flashes in case of error (e.g. if no controller unit 1 is available) and the ERR-LED of the HE 5750 Master controller 1 lights up as well.</p> <p>Stat 2 lights up permanently, if the HE 5750 Master controller 2 is activated.</p> <p>Stat 2 flashes in case of error (e.g. if no controller unit 2 is available) and the ERR-LED of the HE 5750 Master controller 2 lights up as well.</p> <p>Stat 1 and Stat 2 flash alternately, if the connected HE 5750 Master controllers use different software versions.</p>

15.2.3 Display and Operating Elements



Displays / Keys	Meaning
 PWR	Lights up green permanently , if the processor supply (3.3 V) is available.
 RUN	Flashes yellow in Bootloader mode. The switch unit is ready for downloading current software. Lights up yellow , while the application of the switch unit runs. It goes off briefly , if a data pack is sent from the PC to the active HE 5750 Master controller (communication).
 ERR	Lights up red in case of initialisation errors (EEProm, etc.) Flashes red , if no CAN bus is connected during start.
 ACT	This LED is located each at the connectors for the Master controllers. Flashes green briefly , during the internal communication with the HE 5750 Master controllers.
 Service key	See chapter 8.2.4 <i>Service screen F2</i>
 Standby key	See chapter 8.2.5 <i>Standby mode F3 (when operated with switch unit only)</i>

15.2.4 Technical data of switch unit

General	
Supply voltage	24 V DC (18...30 V DC) safety extra-low voltage (SELV)
Power consumption	Max. 30 W (Digital outputs + electronics)
Electrical safety	According to DIN-EN 61010-1, DIN EN 61010-2-201
EMC	Interference immunity: DIN EN 61000-6-2 Emitted interference DIN EN 61000-6-3
Protection class	IP 20
Display	-3 LEDs: operating voltage (green), Bootloader / operation (yellow), Error (red) and <u>additionally</u> -2 LEDs per Master controller: active (green), error (red)
Dimensions	PCB: 160 mm x 122 mm In supporting rail tray: 177 mm x 128 mm x 50 mm
Installation	On supporting rail in switch cabinet, together with two HE 5750 Master controllers
Digital inputs	2 pieces, not galvanically separated, non-isolated PNP, 24 V DC
Digital outputs	-4 pieces, not galvanically separated, non-isolated semiconductor switch (high-side), self-resetting fuse element -Voltage / current per output: -24 V DC / 0.25 A
Communication interfaces	CAN-Bus, RS-232 service interface

Environmental conditions	
Storage	-20°...+70°C
Transport	-20°...+70°C
Operation	0°...+50°C
Relative air humidity	Relative air humidity ≤ 75% annual average
<u>Air pressure:</u>	
during operation and when in storage:	80 kPa to 106 kPa
during transport:	70 kPa to 106 kPa
condensed water	Not permitted
ice	Not permitted
max. operating height above sea level	2000 m

Subject to technical changes without notice!

15.2.5 Pin assignment

Interface		Supply 24 V DC, signal lamp	
Pin designation	X1		
Pin type	Phoenix straight multi-pin connector, 6 pole MSTBVA 2.5 / 6-G-5.08		
Aggregate	Signal	Current no.	
Supply (X1.1)	24 VDC	6	
	GND	5	
	FE	4	
Signal lamp (X1.2)	D-Out1	3	
	D-Out2	2	
	GND	1	

Interface		CAN	
Pin designation	X2, X5, X8		
Pin type	Phoenix straight multi-pin connector, 3 pole MSTBVA 2.5 / 3-G-5.08		
Aggregate	Signal	Current no.	
CAN-Bus (RS-485)	CAN-GND	1	
	CAN-L	2	
	CAN-H	3	

Interface		Digital-I/O Master unit	
Pin designation	X3, X6		
Pin type	Phoenix straight multi-pin connector, 4 pole MSTBVA 2.5 / 4-G-5.08		
Aggregate	Signal	Current no.	
D-In	Input 24 V DC	1	
	24 VDC	2	
D-Out	Output 24 V DC	3	
	GND	4	

Interface		Service	
Pin designation	X4, X7, X9		
Pin type	D_SUB multi-pin connector, 9-pole		
Aggregate	Signal	Current no.	
RS-232	FE	Case	
	RXD	2	
	TXD	3	
	GND	5	

Interface		Service-UART	
Pin designation	X10		
Pin type	RJ-10 modular socket		
Aggregate	Signal	Current no.	
Serial interface TTL	+ 3.3 V	1	
	GND	2	
	Tx	3	
	Rx	4	

16 Maintenance and Service

Maintenance, repair and modification

The devices do not require special maintenance.

Modifications, maintenance and repair must be performed by trained professional personnel only.



Warning!

The use of patched fuses or short circuiting the fuse holder are not allowed.



Warning!

When opening the devices or removing covers and parts, live parts may be exposed. Connection points can also be live. The device must be disconnected from all voltage sources prior to these works.



Warning!

If the failure of a fuse is detected, the cause must be inspected and eliminated. The replacement fuse must have the same data as the original type.



Warning of material damage caused by electrostatic charge!

When opening the devices, components may be exposed that are sensitive against electrostatic discharge (ESD).

The following works must only be performed at work places that are protected against ESD!

Disposal

Dispatch metals and plastics for recycling. Electrical and electronic components must be collected separately and disposed of properly. Dispose of equipped circuit boards properly.

HESCH Industrie-Elektronik GmbH
Boschstraße 8
31535 NEUSTADT, GERMANY
Phone: +49 5032 9535-0
Internet: www.hesch-automation.com
Email: info@hesch.de